

APCO P-25 DIGITAL CAPABLE

BC250D SCANNER

OWNER'S MANUAL



Uniden®

Contents

Introduction	1
Front View	2
Icon Display	3
BC250D SHORTCUTS.....	4
Important Notice	6
Terminology	7
What is Scanning?.....	7
What is Searching?.....	7
What is Trunk Tracking?.....	7
What is APCO Project 25 Digital Communications?	8
Feature Highlights	9
Where to Obtain More Information	11
Information on the Internet	11
Included with Your Scanner Package	12
Setup	13
Installing the Battery Pack	13
Charging the Battery Pack.....	13
Low Battery Indicator	13
Flexible Antenna	14
Beltclip	14
Listening Safely	14
Connecting the REMOTE Cable.....	14
Basic Operation	15
Turn the Scanner On	15
Setting the Squelch	15
Understanding the Menu System	16
Menu Description and Numeric Keypad Equivalents	17
Programming	26
Storing Frequencies into Channels in Menu Mode	26
Deleting a Stored Frequency	27
Editing a Stored Frequency	27
Duplicate Frequency Alert	27
Transfer Frequencies.....	28
Storing Text Tags	28
Beep Alert	29
Programming Tips	29
Scanning.....	31
Storing Frequencies During Scanning.....	31
RF Attenuation Feature	32
Setting the Delay Mode for Frequency.....	32
Channel Lockout.....	33
Restoring a Locked-out Channel	34
Restoring All Locked-out Channels	34
Priority Scan	34
Changing the Priority Channel.....	35
Priority Channel Plus Scan.....	35
Searching.....	36
Setting a Search Range	36
Starting Chain Search.....	37
Search Hold Feature.....	37
Data Skip	37
Frequency Skip.....	38
Storing Search Frequencies	38
Auto Storing	39
Squelch (SQ) Mode	40
Additional Menu Options for Searching	42
Service Search	43

Service Search Skip	44
NWR-SAME Alert	44
Testing the Alert Siren	45
Programming FIPS Code.....	45
Digital and Trunked Systems	47
Programming and Receiving Digital and Trunked Systems.....	49
STEP1: Selecting or Changing Trunking System Type.....	49
STEP2: Programming Trunking Frequencies.....	50
STEP3: Programming ID Scan List Manually.....	51
Scan Lists	51
Setting the Squelch	54
Receiving Trunked Systems.....	54
ID Scan Mode.....	55
ID Scan Hold Feature	56
Trunked Search	56
ID Monitor Mode	56
ID Search Hold and Direct Entry ID Hold Mode.....	57
ID Lockout.....	57
Review ID Lockout.....	58
Restoring Locked-out IDs	58
Setting the Delay Mode for Trunking Mode.....	59
Setting Priority in Trunking Mode	60
Programming Scan Lists During Search	60
Deleting a Stored ID	60
Moving between Scan List Memories.....	61
I-Call (Motorola/EDACS).....	61
Multi-Track	62
EDACS Reception	64
EDACS Tracking.....	64
Programming EDACS System Frequencies.....	64
An EDACS Trunked system	65
Special EDACS Features	66
EDACS SCAT.....	67
LTR Reception.....	68
LTR Tracking	68
Motorola Reception	69
Motorola Tracking.....	69
Fleet Map Programming	70
Selecting Preset Fleet Map	70
Programming a Fleet Map.....	71
Programming a Hybrid System.....	71
Setting the Base, Spacing Frequencies and Offset Channel for Motorola VHF/UHF Trunked Systems.....	72
Toggling the Status Bit	73
Control Channel Only Mode	73
Disconnect Tone Detect Option (End Code)	75
APCO Project 25 Reception.....	76
Installing the APCO P-25 Card.....	76
Precautions for Installing the BCi25D Card	77
Turning ON/OFF the APCO P-25 Card.....	77
APCO P-25 Sound Quality Fine Tuning.....	78
Remote Interface	80
PC Control Mode	80
Clone Mode	81
Additional Features.....	84
Care and Maintenance	87
Troubleshooting	88
Specifications.....	90
Glossary of Terms	91
Appendix.....	95
One Year Limited Warranty.....	105

Introduction

The BC250D is a state-of-the-art Digital Capable radio with TrunkTracker III and automatic scanning capabilities. It can store frequencies such as police, fire/emergency, marine, railroad, air, amateur, and other communications into 10 banks of 100 channels for a total of 1000 channels.

With the optional BCi25D, APCO-P25 Digital Card installed you can monitor Public Safety Organizations who currently use Conventional, Trunked at 3600 and Mixed Mode APCO 25 systems.

Use your new scanner to monitor:

- Police and Fire Departments (including rescue and paramedics)

Trunked for:

Motorola

 Type I

 Type II

 Type I,II (Hybrid)

EDACS

 Wide band

 Narrow band

 Scat

LTR

Digital Communication for APCO Project 25

 Conventional

 Trunked at 3600

 Mixed Mode at 3600





- NOAA Weather Broadcasts
- Business/Industrial Radio
- Utilities
- Marine and Amateur (ham radio) Bands
- Air Band
- And much more...

The chart below identifies the scanner band numbers, the frequency range, the modulation mode and the default step size settings.

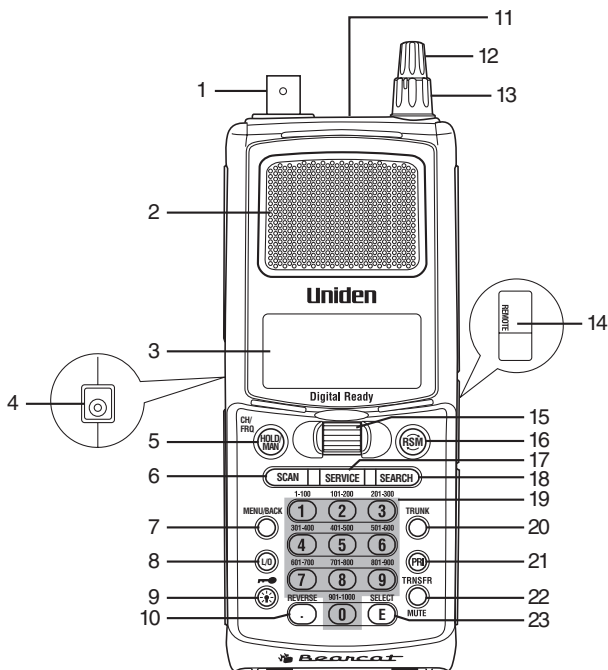

Band No.	Frequency Range (MHz)	Mode	Step (kHz)	Band No.	Frequency Range (MHz)	Mode	Step (kHz)
1	25.0000 - 26.9600	AM	5	15	162.0000 - 173.9875	FM	12.5
2	26.9650 - 27.4050	AM	5	16	174.0000 - 215.9500	WFM	50
3	27.4100 - 27.9950	AM	5	17	216.0000 - 224.9950	FM	5
4	28.0000 - 29.6900	FM	10	18	225.0000 - 399.9500	AM	50
5	29.7000 - 49.9900	FM	10	19	400.0000 - 405.9875	NFM	12.5
6	50.0000 - 53.9900	FM	10	20	406.0000 - 419.9875	NFM	12.5
7	54.0000 - 71.9500	WFM	50	21	420.0000 - 449.9875	NFM	12.5
8	72.0000 - 75.9950	FM	5	22	450.0000 - 469.9875	NFM	12.5
9	76.0000 - 87.9500	WFM	50	23	470.0000 - 512.0000	NFM	12.5
10	88.0000 - 107.9000	WFM	100	24	806.0000 - 823.9875	NFM	12.5
11	108.0000 - 136.9750	AM	25	25	849.0125 - 868.9875	NFM	12.5
12	137.0000 - 143.9950	FM	5	26	894.0125 - 956.0000	NFM	12.5
13	144.0000 - 147.9950	FM	5	27	1240.0000 - 1300.0000	NFM	12.5
14	148.0000 - 161.9950	FM	5				

Front View



1. Antenna Connector
2. Speaker
3. Display
4. DC Power Jack
5. Hold/Manual/Channel/Frequency Key (**HOLD/MAN**)
6. Scan Key (**SCAN**)
7. Menu/Back Key (**MENU/BACK**)
8. Lockout Key (**L/O**)
9. Light/Keypad Lock Key ( / )
10. Decimal/Reverse Key ()
11. Earphone Jack
12. Volume/ON/OFF Control
13. Squelch Control
14. Remote Jack
15. VFO Control
16. Resume Key ()
17. Service Key (**SERVICE**)
18. Search Key (**SEARCH**)
19. Numeric Keypad
20. Trunk Key (**TRUNK**)
21. Priority Key (**PRI**)
22. Transfer/Mute Key (**TRNSFR/MUTE**)
23. Enter/Select Key (**E**)

Icon Display

ICON	DESCRIPTION
	Priority Channel Indicator
L/O	Lock Out Mode Indicator
↑↓	Scan/Search Direction Indicator
SRCH	Chain Search Mode Indicator
SRVC	Service Search Mode Indicator
SCAN	Scan Mode Indicator
ID SCAN	ID Scan Mode Indicator
ID SEARCH	ID Search Mode Indicator
C	Channel Type Conventional Type
M	Trunk Type Morola Tracking Type
L	LTR Tracking Type
E	EDACS Tracking Type
P25	Digital Communications P25: APCO Project 25
AM,FM WFM,NFM	Receiving Mode Indicators
	Signal Meter
	Battery Indicator

Uniden® and Bearcat® are registered trademarks of Uniden America Corporation.

TrunkTracker is a proprietary trademark of Uniden America Corporation.

BC250D SHORTCUTS

To reduce the amount of information that is shown on the display, set up the "Screen Mask".

Press **MENU/BACK** + **3** + **2** + **1**.

To silence the keypad from sounding acknowledgement tones after each press, turn off the "Key Beep".

Press **MENU/BACK** + **3** + **3** + **2**.

To increase the backlight of the display, set the "Dimmer" to HIGH.

Press **MENU/BACK** + **3** + **1** + **1** + **1**.

To decrease the backlight of the display, set the "Dimmer" to MEDIUM.

Press **MENU/BACK** + **3** + **1** + **1** + **2**.

To prevent accidental reprogramming of frequencies or talkgroups, lock out the neat entry Programming.

Press **MENU/BACK** + **3** + **4** + **1**.

To assign an alphanumeric text tag to a bank, choose the bank number; (for example; bank number 1).

Press **MENU/BACK** + **3** + **9** + **1**

To re-enter frequencies on a channel that had already been set; (for example; replace the frequency on channel 5 to 155.000)

Press **SCAN** + **HOLD/MAN** + **5** + **HOLD/MAN** + **1** + **5** + **5** + **.** + **E**.

Rotate the **VFO** control to enter the text and using **RSM** or **HOLD/MAN** to move the cursor. After the text is entered, press **E**.

To receive an alert for activity on a specific channel, turn on the "Beep Alert" for that channel.

Press **MENU/BACK** + **2** + **1** + *select channel* + **E** + **4** + **1**.

To receive an alert for activity on specific IDs while trunk tracking, turn on the "Beep Alert" for that ID.

Press **MENU/BACK** + **2** + **2** + *select bank* + **E** + **3** + *select ID MEMORY* + **E** + **3** + **1**.

This shortcut card is designed to assist you in getting through the menu screens using the direct entry mode for commonly used features. Please read the manual thoroughly before using this card. Be sure to back out of the menu screen after each shortcut by repeatedly pressing MENU/BACK or by pressing SCAN or SEARCH Keys.

BC250D SHORTCUTS

To automatically store frequencies while searching, turn on "Auto Store" after setting up the search range.

Press $\text{MENU/BACK} + 1 + \text{CHAIN SERCH} + \text{E} + 6 + 1 + \text{select bank} + \text{SEARCH}$.

To set up a system for trunk tracking, select a bank, then enter the trunk type.

Press $\text{MENU/BACK} + 2 + 2 + \text{select bank} + \text{E} + 1 + 1$.

Then enter the trunk type you want to track. Press E .

To search a specific range of frequencies, set up the "Search Range".

Press $\text{MENU/BACK} + 1 + \text{CHAIN SERCH} + \text{E} + 2 + \text{select range} + \text{E} + 1$.

Then enter the lower and upper ranges and press E after each Frequency entered.

To begin searching between the Range press SEARCH .

To change the alpha tag on the specific search range of frequencies that you set, do the following:

Press $\text{MENU/BACK} + 1 + \text{CHAIN SERCH} + \text{E} + 2 + \text{select range} + \text{E} + 4$.

Rotate the **VFO** control to enter the tag and use **RSM** or **HOLD/MAN** to move the cursor forward or back and then press E .

To attenuate a specific channel that you set, do the following:

Press $\text{MENU/BACK} + 2 + 1 + \text{select channel} + \text{E} + 5 + 1$.

To change the alpha tag on a specific channel, do the following:

Press $\text{MENU/BACK} + 2 + 1 + \text{select channel} + \text{E} + 1 + \text{E}$.

Rotate the **VFO** control to enter the tag and use **RSM** or **HOLD/MAN** to move the cursor and then press E .

To silence the scanner's audio output, set the scanner to "Mute On".

Press and hold MUTE .

To program and control your scanner remotely from a PC using Uniden's E-Scanner software, do the following:

Press $\text{MENU/BACK} + 3 + 5 + \text{select speed}$

*If you need any assistance with this product, please call our Customer Service Hotline at **1-800-297-1023**. A Uniden representative will be happy to help you with any matters regarding the operation of this unit, available accessories, or any other related matters.*

Hours: M-F 8:00 a.m. to 5:00 p.m., Central time.

*Also please check out our website at **scanner.uniden.com***

Important Notice

- This scanning radio has been manufactured so that it will not tune radio frequencies assigned by the FCC for cellular telephone usage. The Electronic Communications Privacy Act of 1986, as amended, makes it a federal crime to intentionally intercept cellular or cordless telephone transmissions or to market this radio when altered to receive them.
- The installation, possession, or use of this scanning radio in a motor vehicle may be prohibited, regulated, or require a permit in certain states, cities, and/or local jurisdictions. Your local law enforcement officials should be able to provide you with information regarding the laws in your community.
- Changes or modifications to this product are strictly prohibited, or operation of this product in any way other than as detailed by this Owner's manual. Could void your authority to operate this product.
- The screen displays used in this manual are representations of what might appear when you use your scanner.

Terminology

What is Scanning?

Unlike standard AM or FM radio stations, most two-way communications do not transmit continuously. The BC250D scans the Frequencies you have programmed into the Scanner's channels until it finds an active frequency.

Scanning stops on an active frequency and remains on that channel as long as the transmission continues. When the transmission ends, the scanning cycle resumes until another transmission is received.

What is Searching?

The BC250D can search each of its 27 bands to find active frequencies. This is different from scanning because you are searching for frequencies that have not been programmed into your Scanner's channels. The scanner automatically chooses between two speeds while searching. Turbo Search, can search the VHF FM bands at up to 300 steps per second.

What is Trunk Tracking?

Conventional scanning is a simple concept. You enter a radio frequency in your scanner's memory which is used by someone you want to monitor. For example, the police in your area may broadcast on 460.500 MHz, the fire department on 154.445 MHz, the highway department on 37.900 MHz, etc. So when your scanner stops on a frequency, you usually know who it is, and more importantly, you can stop on a channel and listen to an entire conversation. This type of scanning is easy and fun.

As the demand for public communications has increased, many public radio users don't have enough frequencies to meet their needs, and this has created a serious problem. Trunking radio systems solve this problem.

In a trunked radio system, which contains up to 28 different frequencies, radio users are divided into groups, often called talkgroups, and these talkgroups are assigned specific IDs. When someone in a talkgroup uses their radio, a brief burst of data is broadcasted before each transmission. The trunking system computer uses this data to temporarily assign each radio in a talkgroup to an available frequency. If the group using a frequency stops broadcasting or pauses between replies for a few seconds, they are removed from the

frequency so another talkgroup can use it.

Sharing of the available public service frequencies, or trunking, allows cities, counties, or other agencies to accommodate hundreds of users with relatively few frequencies. Following a conversation on a trunked system using a scanner is difficult, if not impossible. Because when there's a short break during the conversation you're monitoring, it's possible that the talkgroup will be assigned to a completely different frequency in the trunked system. This type of scanning is difficult and frustrating.

TrunkTracker III changes this! Not only does your new BC250D scan channels like a conventional scanner, it actually follows the users of a trunked radio system. Once you know a talkgroups ID, you won't miss any of the action.

If you're a new scanner enthusiast, you may want to read the first part of this manual and use your scanner in conventional mode before you begin trunk tracking. Understanding scanning fundamentals and its terminology will make trunk tracking much easier. A glossary of other commonly used terms is provided in the back. (Refer to the "Glossary of Terms" section.) But if you're already an experienced scanner operator, you may want to skip to Programming and Receiving Digital and Trunked Systems on page 49.

What is APCO Project 25 Digital Communications?

APCO Project 25 is a modulation process where voice communications are converted into digital communications. This conversion is similar to the technology used with digital mobile phones. There are several types of project 25 systems available!

- Conventional – one frequency with digital voice.
- Trunked with analog control channel and digital voice – control channel operates at 3600 baud.
- Mixed Mode – trunked system with an analog control channel alternating/mixing analog and digital voice communications.
- Trunked with digital control channel and digital voice. Control channel operates at 9600 baud. (This type of APCO P-25 System is not supported with this radio.)

Feature Highlights

- **Trunk Tracking** – Follow VHF High Band UHF 800/900MHz trunked public safety and public service systems just as if conventional two-way communications were used.
- **Digital Capable** – With the APCO 25 Digital card (BCi25D) installed, you can monitor supported project 25 systems.
- **Multi-Track** – Track more than one trunking system at a time. Scan conventional and trunked systems at the same time.
- **1000 Channels** – Program one frequency into each channel. You must have at least one channel programmed to use the Scan mode.
- **27 Bands** – Includes 27 bands, with aircraft and 800 MHz.
- **10 Banks** – 10 banks with 100 channels each are useful for storing similar frequencies to maintain faster scanning cycles or for storing all the frequencies of a trunked system.
- **25 MHz-1300 MHz** – Indicates the range of frequencies that can be searched within the bands of your scanner.
Note: The frequency coverage is not continuous and excludes the cellular band, 512-806MHz.
- **10 Priority Channels** – You can assign one priority channel in each bank. Assigning a priority channel allows you to keep track of activity on your most important channel(s) while monitoring other channels for transmissions. You can also assign Trunking priority Talkgroups.
- **Priority Plus Scan** – Allows you to scan only priority channels.
- **Preprogrammed Service Search** – Allows you to toggle through preprogrammed public safety, news media, TV broadcast audio, Ham, CB, FRS, special low power, railroad, aircraft, marine, racing, and weather frequencies.
- **Unique Data Skip** – Allows your scanner to skip unwanted data transmissions and reduces birdies.
- **Memory Backup** – If power is disconnected, the frequencies programmed in your scanner are retained in memory.
- **Direct Channel Access** – Go directly to any channel without entering the Menu mode.
- **Attenuator** – Reduces the signal strength on a per frequency basis.

- **PC Programmable** – Allows you to easily program all frequencies and Trunking Talk Groups into your BC250D through Uniden's E-Scanner software running on your PC. – For more information on E-Scanner Programming software visit our website at scanner.uniden.com.
- **Turbo Search** – Increases the search speed to 300 steps per second. This applies only to transmission bands with 5 kHz steps.
- **Text Tags** – You can customize your scanner by storing text tags (up to 16 characters).
- **Auto Store** – The scanner automatically stores found active frequencies into an assigned bank.
- **CTCSS/DCS** – The scanner can receive and search for subaudible tones.
- **NWR-SAME Alert** – The scanner is compatible with warning siren and message transmissions.
- **FIPS Code** – Six digit FIPS Code (emergency and geographic area code) programmable.
- **LCD Back-Light** – LCD illuminates when you press the **Light/Lock** (* / ←) key. You can select the lighting length of time in the Menu mode.
- **Battery Save** – In Scan Hold mode and no transmission, your scanner automatically reduces its power requirements to extend the battery life.

Where to Obtain More Information

Before using your scanner, you must program frequencies into available channels. The Betty Bearcat Frequency Guide lists typical frequencies used around the U.S.A. and Canada that you may program into your new scanner.

To obtain frequency information for your area, contact one of the following:

- Bearcat Frequency Hotline
(937) 299-0414 (Hours are from 9:00 a.m. to 5:00 p.m. Eastern Time Monday through Friday.)
- Bearcat Radio Club
(800) 423-1331 (Hours are from 8:00 a.m. to 5:00 p.m. Eastern Time Monday through Friday.)
- Scanner Master
(800) 722-6701 (Hours are from 10:00 a.m. to 5:00 p.m. Eastern Time Monday through Friday.)

To obtain another copy of the frequency guide, contact one of the following:

- Uniden Parts Department
(800) 554-3988 (Hours are from 7:00 a.m. to 5:00 p.m. Central Time Monday through Friday.)
- Local Dealer

Information on the Internet

If you have access to the internet, you may want to visit one of the following websites for additional information:

scanner.uniden.com
www.bearcat1.com

Included with Your Scanner Package

If any of these items are missing or damaged, immediately contact your place of purchase or Uniden Customer Service at: (800) 297-1023, 8:00 a.m. to 5:00 p.m., Central Time, Monday through Friday.

- BC250D Hand held Scanner
- AC Adapter/Charger (AD-600U)
- Ni-MH Battery (BP-250)
- Rubber Antenna
- Remote Cable
- Beltclip
- Operating Guide
- E-Scanner Programming Software CD-ROM
- Trunk Tracker Frequency Guide
- Other Printed Material

Setup

Installing the Battery Pack

1. Open the cover.

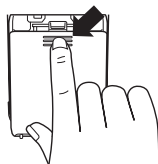

2. Connect the battery pack connector observing the correct polarity.

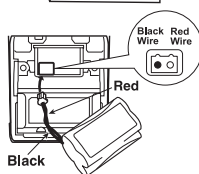

3. Replace the cover and press down until it clicks into place.

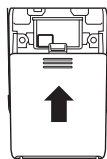

Charging the Battery Pack

Use the AC Adapter/Charger to power the BC250D from an AC outlet.

You can use your scanner while the battery charges. To fully charge the battery, leave the AC Adapter/Charger connected for 14 — 16 hours.

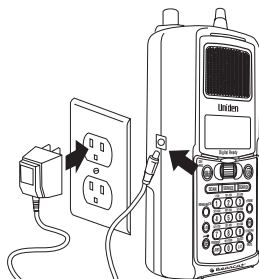

Use only the supplied AC Adapter

Note: Disconnect the AC Adapter/Charger from the unit when charging is complete.

Low Battery Indicator

When the battery pack is low and needs to be charged,  appears on the display. You will also hear a beep every 15 seconds as an audible alert.

Flexible Antenna

Attach the flexible antenna to the antenna connector.

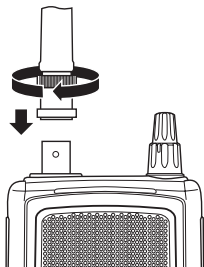

Beltclip

The beltclip is designed to fit snugly on the back of the scanner.

Line up the four arms on the beltclip with the four tabs on the scanner and slide the beltclip into place, as shown on the right.

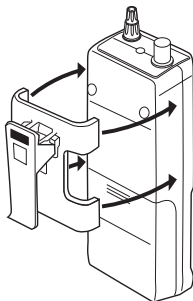

Listening Safely

To protect your hearing, follow these guidelines when you use an earphone or headphones.

- **Do not use the earphone to listen to the WX alert siren test. The volume is not adjustable and damage to your hearing could occur.**
- Do not listen at extremely high volume levels. Extended high volume listening can lead to permanent hearing loss.
- Set the **VOLUME** to the lowest setting before you begin listening. After you begin listening, adjust the **VOLUME** to a comfortable level.
- Once you set the **VOLUME**, do not increase it. Over time, your ears adapt to the volume level, so a volume level that does not cause discomfort might still damage your hearing.

Connecting the REMOTE Cable

You can transfer the programmed channels, talk group ID's, etc. to and from another BC250D or BC785D scanner using a remote cable. See "Clone Mode" on page 81. You can also upload or download the programmed data to or from a PC using Uniden's E-Scanner software. See "PC Control mode" on page 80.

Basic Operation

Turn the Scanner On

Turn the **VOLUME** control clockwise out of the detent position. The scanner automatically starts scanning. Since there are no frequencies programmed in your scanner initially, you may not receive any signals. Once you set the squelch and program some frequencies, you will begin hearing conversations regularly.

Note: If you turn the scanner on when the optional APCO card is not installed, **APCO P25 CARD NOT INSTALLED** appears on the display. To delete the message, select **2:DISABLE** in the Menu mode (see page 77).

Setting the Squelch

To set the squelch, you must be in the hold mode, and you should not be receiving a signal on your scanner.

1. Press **HOLD/MAN** until you do not hear a signal.
2. Make sure that the **VOLUME** is set to a comfortable listening level.

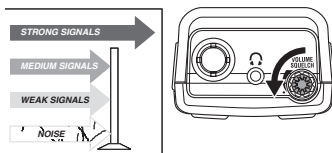

3. Think of the Squelch Control as a gate. Turn the **SQUELCH** control fully counter-clockwise. This raises the "Squelch Gate" so high that only very strong signals can get through.

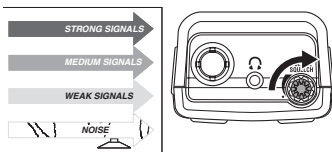

4. Turn **SQUELCH** clockwise until you hear a hiss. This lowers the "Squelch Gate" so that everything gets through – noise, weak signals, medium signals and strong signals.
5. Turn **SQUELCH** back counter-clockwise just until the hiss stops. Now the "Squelch Gate" allows only clear signals through.

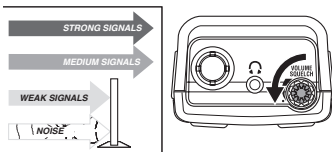

Next you must program some frequencies (page 26). It is recommended that you read the next part "Understanding the Menu System" because it will assist you in accessing and understanding many of the features. Later in a section called "Additional Features", you will find explanations on how to disable the keypad acknowledgement tones, mute the audio, change the appearance of the display and other general features.

Understanding the Menu System

It is very important for you to understand the Menu screen. To navigate through the Menu screen is really quite simple. Many of the features of this scanner, can only be accessed by the Menu screens. There are several ways to get through the screens. First of all, press **MENU/BACK** to get started. Anytime you want to exit this mode or simply quit from where you are, repeatedly press **MENU/BACK** until the scanner returns to the original state or you can press **SCAN** or **SEARCH** to exit directly out of Menu mode. Anytime you are in the Menu mode, the audio will be muted.

To assist you in understanding the Menu screen, flow charts are provided towards the back of the manual so you can follow along. Two things to remember are *rotate the VFO* through the menu and press **E** to *execute* the command. For simplicity, we have chosen to rotate the **VFO** control up or down in order to *scroll* through the menu and the **E** key for *entering or executing* a command. Once you have pressed the **E** key and executed the final choice (for instance, **ON** or **OFF**), the display backs up to the previous level of options.

Also direct entry of the numbers in the flow chart will get you through the screens, but the other screen options are not visible. This method should be used only after you have gone through the manual at least once. Tearout shortcut cards (see pages 4 and 5) are provided to assist you in the direct entry methods for commonly used features.

The illustration on the next page shows the first level of the Menu screen. These levels are then provided in a flow chart on pages 102 to 104. You will find a description section to explain the meanings of these functions on the next pages. Then, you will be walked through all the steps of programming, scanning, searching, and trunktracking.

-  **Hint:** You can check the various options you programmed on the display when you press and hold **MENU/BACK** for 2 seconds in the following modes.
- Scan mode/Scan Hold mode (as well as Trunk mode).
 - Chain Search mode/Chain Search Hold mode

- ID Search mode/ID Search Hold mode

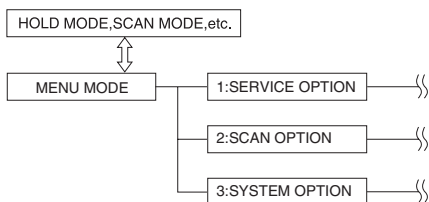

Menu Description and Numeric Keypad Equivalents

Below are the Menu screens and a brief description or purpose of the feature.

1:SERVICE OPTION

Service Search menus are preprogrammed services used around the U.S.

1:WEATHER

1:MONITOR

When you select this mode, the preprogrammed NOAA weather channel begins to activate.

2:ALERT

You can set NWR-SAME weather alert to 1:ON or 2:OFF. With ALERT ON you can enter the mode to program your FIPS code.

2:PUBLIC SAFETY

3:NEWS

4:TV BROADCAST

5:HAM RADIO

6:MARINE

7:RAILROAD

8:AIR

9:CB RADIO

0:FRS

:RACING

:SPECIAL

:CHAIN SEARCH

You can program up to 10 search ranges. The first time you program a range you will need to do so through the Menu. After the first time you can program a range as you do on most any other scanner, using the numeric keypad or **VFO** control. Use this Menu item to select the search range that you want to program. You can program range 1 through 10, one at a time. For each of the ranges, the following options can be modified.

1: CHAIN SEARCH

You must turn Chain Search feature ON, in order to use the Chain Search feature.

2: SEARCH RANGE

1: RANGE

Enter the upper and lower frequency limits of the Search Range.

2: STEPS

You can assign a variety of step sizes to the search range.

Note: The default step is usually acceptable and is listed on page 1.

3: MODE

You can change the Auto receive mode to AM, FM, WFM, NFM.

4: ALPHA TAG

You can enter an Alpha Tag for any or all of the search ranges.

5: TRUNK

During Chain Search mode, when the scanner finds an active frequency. The trunk tracking system will be active. Four frequency plans apply to the Control Channel Only feature (for details see page 73).

3: DELAY

Set the delay for the search ranges to 1: ON or 2: OFF. This applies to Search mode, and Service Search mode (See 2: SCAN OPTION / 1: CONVENTIONAL / 2: DELAY for details).

4: ATTENUATOR

Set attenuation for all search ranges. (See 2: SCAN OPTION / 1: CONVENTIONAL / 5: ATTENUATOR for details).

5: TONE DATA

The default mode is 2: OFF. This means that you will receive all transmissions on any frequencies that are active within your search range(s). By selecting CTCSS or DCS you can set the radio to receive only a particular subaudible tone to be received during your search. You can also lockout a particular CTCSS or DCS tone. You may wish to do this if you want to search a range but not hear transmissions on any frequency that has a particular subaudible tone.

Note: Through the System Menu you can set the radio to operate in Tone Search mode during Search as well. In this mode, the radio will automatically determine the active subaudible tone on any frequency received during the search.

6: AUTO STORE

You can automatically store active frequencies found during a search into the memory. You can select which bank you want to program the found frequencies. The audio will be muted during Auto Store.

2: SCAN OPTION

1: CONVENTIONAL

Choose the channel number. The following options are available for the selected channel only. Repeat using a different channel number, if necessary.

1: FREQUENCY

Allows you to edit or enter a frequency in each channel you select.

Also you can set an alphanumeric text tag for each programmed frequency.

2: DELAY

The delay for all programmed channels is 2 seconds. At the end of any transmission the scanner will remain on the frequency for 2 seconds before resuming scanning. This will allow you to catch most replies.

3: TONE DATA

You can set a CTCSS (analog) or DCS (digital) subaudible tone for a frequency.

To do so you must have the SQ Mode in the System Menu set to Tone SQ. You can also program a subaudible tone easily by pressing the **E** key in Scan Hold mode after programming a frequency. This will bring up the Tone Data menu without having to navigate the Menu. By doing this you will receive all transmissions on the frequency, regardless of the subaudible tone, except the one which you have locked. Any transmissions with that tone will not be received.

4: BEEP ALERT

You can set a Beep Alert on a per-channel basis to alert you when specific frequencies are active. For example, you may wish to be alerted anytime a mutual aid fire frequency is active. With Beep Alert, you will hear three beeps at the start of each transmission that you have flagged as such. You will also notice that as you scroll pass the flagged channel(s), you will hear three beeps.

5: ATTENUATOR

The BC250D comes with an RF Attenuation feature. If you are near an unusually strong signal source, the signal may overload the scanner. The scanner may stop repeatedly on that signal and miss other transmissions. The RF Attenuation feature works in all modes and attenuates (reduces) the incoming signal strength to prevent stronger signals from overloading the scanner.

6: STEPS

Your BC250D is programmed with default step sizes for each frequency range (see page 1). Steps are important if you are interested in using the **VFO** to tune off from a frequency programmed into memory or if you wish to program a frequency that the default step size will not accept. For example, in VHF High Band mode, the default step size between 148 and 162 MHz is 5 KHz. However, the FCC has recently instituted 7.5 KHz channel intervals. If you wish to enter 155.4075 into the scanner without changing the default step, the scanner will change the programmed frequency to 155.4100. Use the Menu to change the default step size to 7.5 KHz and then you will be able to enter 155.4075.

7: MODE

Default Auto receive modes are also programmed into memory. AM for aircraft and CB bands, for example. All frequencies (other than audio TV broadcast) above 400 MHz are received in NFM mode which helps prevent adjacent channel interference. You can change the default settings on a per-channel basis with this Menu item.

2: TRUNK

Choose the Trunk bank. The following options are available for the selected trunk bank only. Repeat using a different trunk bank, if necessary.

1: TRUNK TYPE

You will need to assign the correct trunking type for the bank you are about to program. If you want to listen to a Motorola Type I system, you will need to use this Menu option to assign the same. If you do not know the type of trunking system you are about to monitor, refer to the guide included with the scanner or check out www.bearcat1.com.

Note: Some trunking systems require that you know the channel order. In these cases you will also need to start programming the trunked system at the start of the bank. The scanner defaults to the most common type of trunking system, Motorola Type II 800.

2: TRUNK CHANNEL

1: FREQUENCY

To use Trunk Tracking, you need to program a frequency for at least one channel. Also you can enter an alpha tag for each channel in this Menu.

2: STEPS

You can assign a variety of step sizes to the channel.

3: TALK GROUP

You can program IDs into the Scan List memory either during Trunk Scan or Search without going into the Menu. However, you can also use the Menu to program IDs. This is particularly helpful when you are not near the trunked system you wish to later monitor. You can set it up and have it ready to go at some later time. After you have selected the Scan List location (1-10), you

can then do the following:

1. Program ID number
2. Set an alpha tag
3. Assign a Beep Alert to the ID. Whenever that ID is active, you will hear three beeps at the start of the transmission.

4: DELAY

You can set a delay for a trunk system on a bank by bank basis. The delay time is 2 seconds, and this setting can not be changed.

5: ID LIST TAG

Assign an alphanumeric tag to any or all of the 10 Scan Lists for the system. During ID Scan Mode, you will see the ID List Tag (on the bottom text line) along with any alpha tag you may have set for an ID. In Search mode, you will see any Bank Tag you have set.

6: L/O ID REVIEW

Use this Menu item to review the IDs that you have locked out during Search and Scan. Rotate the **VFO** up or down to view the IDs that have been locked out. To leave the lockout IDs unchanged, press **MENU/BACK** to back out of the Menu. To unlock an ID, press the **L/O** key. To unlock all the IDs that have been locked out, press and hold the **L/O** key for about 2 seconds.

7: ACTIVITY ID

When activity ID is set to ON, your scanner receives any transmissions on the ID every 0.5 seconds while scanning.

8: I-CALL (MOTOROLA/EDACS)

Most communications within a trunked system are group calls where one unit (such as a dispatcher) communicates with all the units within his/her group (all the patrol vehicles on the east side of town, for example). The units within this group comprise what is typically known as a talkgroup. There are some communications which are direct unit-to-unit conversations where one individual converses with another individual. The call is initiated by a radio and is directed to another single radio. Within the system, no one outside of these two users hears the conversation.

Your BC250D defaults to I-CALL OFF mode. You can hear these conversations by using this Menu item to turn the I-CALL function to

ON. In Search mode, with I-CALL ON, you will hear both talkgroup calls and I-CALLS. You can also set I-CALLS to I-CALL ONLY during which you will monitor only I-CALLS in Search mode. You can also program I-CALL IDs into Scan List memory.

OR

8: ID SCAN LIST (LTR)

When scanning an LTR system you can only turn Scan Lists OFF and ON when an LTR talk group that you have entered into memory is active. To provide you with another method to turn Scan Lists ON and OFF, you can use this Menu item which only appears when you have selected LTR in trunk type.

9: EMERGENCY ALT (EDACS)

In EDACS trunked systems, you can set an alert for an EDACS transmission received. Set Emergency Alert to ON, EMERGENCY flashes on the display and you will hear beep alerts when you receive an EDACS emergency transmission.

9: STATUS BIT (MOTOROLA)

On Type 2 trunking systems there is a method by which specialized types of communications utilize unique talkgroup numbers. An emergency call will occur on a unique talkgroup from its primary assignment, for example. Because the BC250D defaults to Status-Bit ON mode, you never need to worry about missing these transmissions. If you've programmed talkgroup 33264 into Scan List memory, for example, and there is an emergency call within the group, you will hear it on 33264.

0: EDACS ID FORM (EDACS)

You can change to display the talkgroups in decimal mode, but this mode does not provide you with the flexibility that you get with AFS. The BC250D defaults to show the talkgroup number in AFS mode (Agency-Fleet-Subfleet). For details on AFS see pages 65~67.

OR

0: END CODE (MOTOROLA)

When this function is disabled, the radio looks for squelch before returning to the control channel instead of waiting for the disconnect

tone. Only in rare instances will you need to adjust the default settings. The condition to return to control channels depends on whether a signal is present or not.

:CNTRL CH ONLY
(TYPE 1/TYP E 2 800, 900)

With this mode you will be able to track Motorola Type I and II 800 and 900 MHz trunked systems by simply entering the control channel which manages the trunked system. You will not have to program the voice channels. There are 4 channel plans which you can select from.

3:SYSTEM OPTION

1:DIMMER

Allows you to change the brightness of the display. Also you can change the lighting length of time.

2:SCREEN MASK

Screen Mask allows you to limit what appears on the display to the alpha tags that you have set for a channel along with a few function icons. Screen Mask removes the frequency, receiving mode tone data and signal strength bars. This mode is particularly useful in public safety vehicles where "information overload" is already a problem. Screen Mask does not work in Search mode.

3:KEY BEEP

Use this function to turn **2:OFF** the keypad acknowledgement beep. The default setting is **1:ON**.

4:ENTER LOCK

Use Enter Lock to prevent accidental re-programming of channels, tone (CTCSS/DCS) and talkgroups entered into memory. The default setting is **2:OFF**.

5:PC CONTROL

Use this function to set the transfer speed (baud rate) at which your personal computer (PC) communicates with the scanner when downloading information into your scanner using the Uniden's E-Scanner software. See page 80 for details.

6:CLONE

You can clone all the programming, including frequencies, talkgroups and alpha tags as well as bank settings and other parameters from one BC250D to a BC785D or another BC250D.

7:DATA SKIP

A scanner will normally stop on any transmission it receives. This means the BC250D will occasionally stop on data signals and unmodulated transmissions. You can automatically skip many of these types of transmissions with data skip turned ON.

8:SQ MODE

The SQ Mode allows you to set at your option, whether the scanner will stop on all active transmissions on a particular frequency or it will only respond to transmissions with a pre-set subaudible tone. This applies to both Conventional Search and Scan modes. The options are as follows:

1. CSQ - The default setting is CSQ (carrier squelch). In this mode the scanner will stop on any transmission on a programmed frequency (Squelch mode does not apply to trunking).
2. TONE SQ - In Tone Squelch mode, if you have set a subaudible tone (CTCSS or DCS) for a frequency, the scanner will only stop on that frequency if the transmission includes the prescribed tone.
3. TONE SEARCH - In this mode, as soon as the scanner stops on any (non-trunked) channel, the scanner will begin to search for any subaudible tone that is being used on a transmitted frequency. The scanner will check each CTCSS tone sequentially and it will find DCS tones instantly.

9:BANK TAG

Allows you to set an alphanumeric text tag for individual banks in the scanner (1-10). (The "0" key represents bank number 10.) For example, you may wish to set the bank one text tag as Law Enforcement, the second bank as Fire, etc.

0:P-25 CARD

When you insert the optional card (BCi25D) and select 1:ENABLE in this mode, you can monitor APCO P-25 digital communications. See page 76 for details.

:BATTERY SAVE

When you set Battery Save to ON in this Menu, Battery Save is active in Scan Hold mode (except Priority Scan mode).

Programming

Before the BC250D can begin conventional scanning, you must program a frequency into at least one channel.

Repeat this procedure for each channel you want to program.

Storing Frequencies into Channels in Menu Mode

1. Select frequencies you received from your dealer, from various sources on the internet, or from one of the guides listed on page 11.

LOCATION	BASE	MOBILE
PAYETTE	460.150	465.150
PINEHURST	155.490	***.***
POCATELLO	154.725	***.***



Here is a list of sample frequencies you should try:

- 156.800 Marine Calling channel
- 155.340 Ambulance operations
- 155.280 Ambulance operations
- 155.160 Ambulance operations
- 462.950 Ambulance operations
- 462.5625 Family Radio Services (channel one)

2. Press **MENU/BACK**.
3. Select **2: SCAN OPTION / 1: CONVENTIONAL** by rotating the **VFO** and pressing **E**.

4. Select a channel.
 - a. Enter the channel number using the keypad.
 - b. Then press **E**.

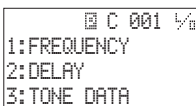
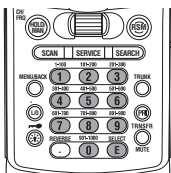

5. Select **1: FREQUENCY**, and press **E**.
 - a. Enter the frequency number using **.** (decimal key) and the keypad.
 - b. Then press **E**.

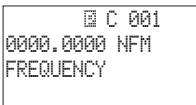

6. Enter the alpha tag and press **E**. (See page 28.)

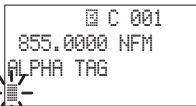

7. The following display appears, select the location you want.

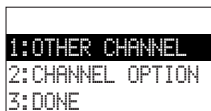

Note: • To clear a mistake while entering the frequency, press \ominus (decimal key) repeatedly until the display is cleared.

- If you enter a channel or frequency which is out of the scanner's range, a beep will sound and **ERROR** appears on the display.
- For each channel, you can also change the step size or the mode. (See page 103.)

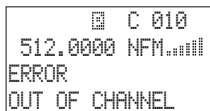

C 010
512.0000 NFM...
ERROR
OUT OF CHANNEL

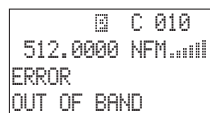

C 010
512.0000 NFM...
ERROR
OUT OF BAND

Deleting a Stored Frequency

To delete a stored frequency:

- Select a channel.
- Press **0**.
- Then press **E**.

Note: Channels with no frequencies are automatically locked out.

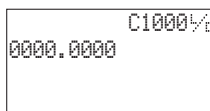

C1000 1/2
0000.0000

Editing a Stored Frequency

- Press **MENU/BACK**.
- Select **2:SCAN OPTION / 1:CONVENTIONAL** by rotating the **VFO** and pressing **E**.
- Select the channel number you want to edit by rotating the **VFO** and pressing **E**.
- Select **1:FREQUENCY** by rotating the **VFO** and pressing **E**.
- Edit the frequency by using \ominus (decimal key) and the keypad and pressing **E**.

Duplicate Frequency Alert

If you enter a frequency which has been stored in another channel, you will hear a beep and the channel stored displays **WARNING**.

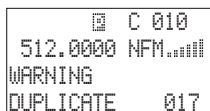

C 010
512.0000 NFM...
WARNING
DUPLICATE 017

Press \ominus (decimal key) to clear and start again.

— OR —

Press **E** again to store the frequency in both channels.

Transfer Frequencies

You can transfer a frequency that has been stored in a channel to another channel.

1. Press **HOLD/MAN**.
2. Press **TRANSFR**, and the smallest empty channel number along with the frequency will flash on the display.
3. Press **E** and the frequency can be stored in this channel.
4. If you want to enter it into another channel, select another channel by rotating the **VFO** and pressing **E**.

Note: When the frequency is transferred, channel data along with the frequency is also transferred. For trunked frequency, data related to trunking, such as Trunk Type or Fleet Map will not be transferred. You will need to input the data manually.

Storing Text Tags

You can customize your scanner by storing text tags for easy identification of banks, channel transmissions, trunking talkgroup IDs, etc. The text tags can be set at the Menu mode. (Refer to “Understanding the Menu System” on page 16.)

For programming text tags for trunked talk group ID’s, please refer to page 53.

Assigning a Bank Tag to a Bank

1. Press **MENU/BACK**.
2. Select **3:SYSTEM OPTION / 9:BANK TAG** by rotating the **VFO** and pressing **E**.
3. Select the bank number by rotating the **VFO** and pressing **E**.
4. The cursor appears on the display. Scroll the **VFO** to change the letters, and then press **HOLD/MAN** or **RSM** to move right or left. Both capital and lower case letters are available, as well as numbers and punctuation marks.
5. After entering the desired text, press **E**.

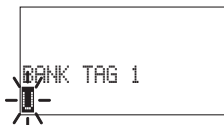

Assigning a Text Tag to a Channel

1. Press **MENU/BACK**.
2. Select **2:SCAN OPTION / 1:CONVENTIONAL** by rotating the **VFO** and pressing **E**.

3. Select the channel number by rotating the **VFO** and pressing **E**. You can also enter the channel number by using the keypad and then press **E**.
4. Select **1:FREQUENCY** and **ALPHA TAG** by rotating the **VFO** and pressing **E**.

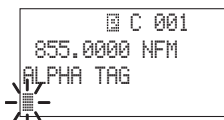

Note: You can only assign a text tag to the channel where the frequency is stored.

5. The cursor appears on the display. Rotate the **VFO** to change letters, and press **HOLD/MAN** or **RSM** to move right or left. Both capital and lower case letters are available, as well as numbers and punctuation marks.
 6. After entering the desired text, press **E**.
- ☞ Remember! To clear a mistake while entering the letters, press **HOLD/MAN**, **RSM** or \odot (decimal key) repeatedly until the display is cleared.

Beep Alert

The scanner can alert you with three beeps at the beginning of a transmission on an assigned frequency.

Assigning the Beep Alert to a Channel

This alert can be set ON/OFF for every channel in Conventional mode.

In conventional mode -

1. Press **MENU/BACK**.
2. Select **2:SCAN OPTION / 1:CONVENTIONAL** by rotating the **VFO** and pressing **E**.
3. Select the channel number by rotating the **VFO** and then pressing **E**. (You can also enter the channel number by using the keypad and then press **E**.)
4. Select **4:BEEP ALERT** by rotating the **VFO** and pressing **E**.
5. Select **1:ON** or **2:OFF** by rotating the **VFO** and pressing **E**.

Note: If **NOT REGISTERED** appears, make sure a frequency is stored in the channel.

Programming Tips

- Do not program a weather frequency into one of the channels, since weather channels transmit continuously. Use the Weather Search feature to select the weather information band.

- Group similar services into a bank. For example, program police frequencies in channels 1 through 10 and fire/emergency into channels 51 through 60, and so on.
- Put the frequency that you listen to the most or the most important frequency into a Priority channel.
- To quickly program a series of channels, start with the lowest number channel.

For example, when you are programming five new frequencies into channels 4 through 8, start with channel 4. After you finish programming a channel, rotate the **VFO** up to go to the next higher channel.

- Write down your programmed channels and frequencies and put them in a convenient place in case of accidental reprogramming.
- Frequencies are rounded off according to the step of each channel.
- When you are overwriting a tagged channel with a new frequency, the previous alpha tag will be deleted. You must re-enter the alpha tag.
- When programming frequencies, a 2 second delay is set automatically and can not be changed.

Scanning

1. After programming frequencies, simply press **SCAN** to begin scanning. During scanning, when you rotate the **VFO**, you can select the direction (↑ or ↓) you want to scan.

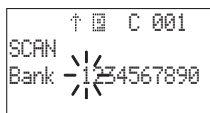

2. The bank indicators selected for scanning appear on the display, and the bank being currently monitored flashes. You can deselect banks from active scanning by entering their number on your keypad. The indicator for each deselected bank disappears, and the bank's channels are not scanned.

Note: One bank must always be active. You cannot deactivate all ten banks at the same time. If you try to deselect all the banks, the first bank is automatically selected.

To restore a bank to active scanning, enter the bank's number on your keypad. The bank's indicator will display again.

3. During normal scanning the scanner skips unprogrammed or locked out channels.
4. When a transmission is received, the scanner stops on that channel. When the transmission ends, scanning resumes automatically.

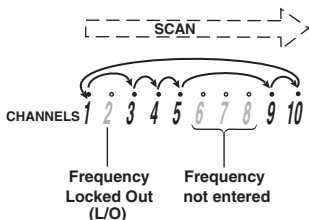

Another method is as follows:

1. Press **HOLD/MAN**.
2. While the **VFO** setting is in the channel mode, rotate the **VFO** until the desired channel is displayed.

Note: When in Hold mode, you can use the **VFO** to step up or down through the channels. You can also switch from stepping up/down through channels to stepping up/down through frequencies by pressing the **HOLD/MAN** button for 2 seconds.

Storing Frequencies During Scanning

During Scanning

1. Press **HOLD/MAN**.

2. Press **TRNSFR**, and the smallest empty channel number flashes on the display.
3. Press **E**.

Note: • If you want to change the channel, rotate the **VFO**.

- If the frequency you want to store exists already, **WARNING** appears on the display and you will hear a beep. (See “Duplicate Frequency Alert” on page 27).



RF Attenuation Feature

The BC250D comes with an RF Attenuation feature. If you're near an unusually strong signal source, the signal may overload the scanner. The scanner may stop repeatedly on that signal and miss other transmissions.

The RF Attenuation feature works in all modes and attenuates (reduces) the incoming signal strength to prevent stronger signals from overloading the scanner.

The RF attenuation is set at the Menu mode.

1. Press **MENU/BACK**.
2. For Search mode, select **1:SERVICE OPTION / :CHAIN SEARCH/4:ATTENUATOR / 1:ON** by rotating the **VFO** and pressing **E**.

OR

For Scan mode, select **2:SCAN OPTION / 1:CONVENTIONAL** by rotating the **VFO** and pressing **E**. Then select the channel number by rotating the **VFO** and pressing **E**. Select **5:ATTENUATOR** by rotating the **VFO** and pressing **E**.

3. Select **1:ON** by rotating the **VFO** and pressing **E**.

Note: Attenuation will only be active for the specified channel. In Search mode, it is applied to the search ranges in all banks.

Setting the Delay Mode for Frequency

The delay of 2 seconds is automatically set for each frequency. To set the delay feature, enter into the Menu mode.

1. Press **MENU/BACK**.
2. For Scan mode, select **2:SCAN OPTION /**

1: CONVENTIONAL by rotating the **VFO** and pressing **E**.

3. Select the channel number of the stored frequency to be delayed by rotating the **VFO** and pressing **E**.
4. Select 2: DELAY and press **E**.
5. Rotate the **VFO** to select 1: ON or 2: OFF and press **E**.
6. For Search mode, select 1: SERVICE OPTION / 2: CHAIN SEARCH/3: DELAY by rotating the **VFO** and pressing **E**, then set to 1: ON or 2: OFF the same way as the Scan mode setting.

Channel Lockout

You can lockout any channel so it is not checked during normal scanning. You can restore the channel to scanning when you wish.

Lockout in Hold Mode

1. Press **HOLD/MAN**.
2. Select a channel.
 - a. Enter the channel number using the keypad.
 - b. Press **HOLD/MAN** again.

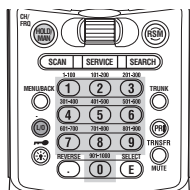

— OR —

Rotate the **VFO** up or down to change the channel.

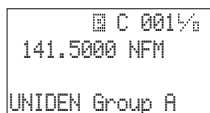

3. Press **L/O** to lockout the channel.
L/O appears on the display.

Lockout in Scanning Mode

If the scanner keeps stopping on a particular channel due to noise or frequent transmissions, you may want to keep that channel from scanning.

1. Wait until the scanner stops on the channel.
2. Then press **L/O**.
3. The scanner immediately resumes scanning because the locked out channel is no longer in the scanning sequence.

Lockout Tips Write down your locked-out channels and put in a convenient place in case you need to restore them.

Restoring a Locked-out Channel

1. Press **HOLD/MAN**.
2. Select a locked out channel.
 - a. Enter the channel number using the keypad.
 - b. Then press **HOLD/MAN** again.
3. Press **L/O** to unlock the channel.
The **L/O** icon disappears.

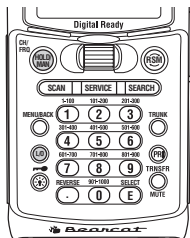

Restoring All Locked-out Channels

You can restore all locked-out channels in a bank only when a bank is selected for scan. If you have deselected a bank and you want to restore all of its locked-out channels using the steps below, you must press **SCAN** and then enter the number of the bank on your keypad.

1. Press **HOLD/MAN**.

Note: You must be in Hold mode before restoring all locked-out channels.

2. Press and hold **L/O** for about 2 seconds.
You will hear two beeps when all the channels have been restored.

Priority Scan

When Priority Scan is turned ON, your scanner checks the priority channel in the banks you selected every 2 seconds for activity. If a signal is present on the priority channel, your scanner monitors the channel until the transmission ends, then resumes normal scanning. You can designate one channel in each bank as a Priority Channel. By default, the first channel in each bank is the Priority Channel, but you can change this.

To activate Priority Scan (in either the Hold or Scan Mode):

1. Press **PRI** to select **PRIORITY ON**.

Note: If you have locked out the priority channel, **ERROR** appears when you select Priority mode.

```
PRIORITY ON
```

2. Press **PRI** to select **PRIORITY OFF** to deactivate Priority Scan.

```
          C 010  
1240.0000 NFM.....  
ERROR  
PRI CH LOCKOUT
```

Changing the Priority Channel

You cannot eliminate the Priority Channel, but you can change it to any one of the 100 available channels in each bank.

1. Press **HOLD/MAN**.
2. Select a new Priority Channel:
 - a. Enter the channel number using the keypad.
 - b. Then press **HOLD/MAN** again.
3. Press and hold **PRI** for 2 seconds to designate this channel as your new Priority Channel.
Two beeps indicates that the Priority Channel has been changed. The **P** icon appears on the display.

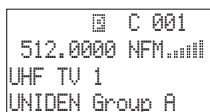
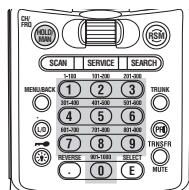

- Note:**
- Priority in Trunking mode works just the same, except you set them for talkgroup IDs, instead of setting priorities for channels. The scanner only checks priority talkgroups between transmission, in 4 second intervals.
 - Priority Scan is disabled while M, E or L (Trunking type) icons are illuminated (a beep will sound if you try to scan). To make it possible, turn OFF each function then press **PRI** to select **PRIORITY ON**.

Priority Channel Plus Scan

You can scan only the Priority Channels (except for the lock out channels) in the banks you selected. To activate Priority Channel Plus

(Only in Scan mode):

1. Press **PRI** to select **PRIORITY PLUS**.
2. Press **PRI** to select **PRIORITY ON** or **PRIORITY OFF** on the display to deactivate Priority Channel Plus Scan.

Note: Priority or Priority Plus Scan are disabled while Search mode is selected.

Searching

Setting a Search Range

Note: First you must set the search ranges through the Menu screen prior to any searching.

The BC250D can search up to 10 separate frequency ranges to help you discover new stations in your area.

To set a Search Range, enter into the Menu mode.

1. Press **MENU/BACK**.
2. Select 1:SERVICE OPTION /:CHAIN SEARCH /2:SEARCH RANGE - by rotating the **VFO** and pressing **E**.
3. Select a range number by rotating the **VFO** and pressing **E**.
4. Select 1:RANGE by rotating the **VFO** and pressing **E**. Enter the lowest frequency using the keypad and then press **E**, then repeat the same for the highest frequency. Then press **SEARCH**.

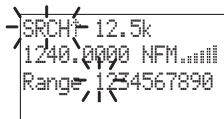

— OR —

Another method is as follows:

1. Press and hold **SEARCH** for 2 seconds.
2. Select -range number-1:RANGE and program the lowest and highest frequencies the same way as step 3 and 4 above.

- Note:**
- The scanner can continuously search up to 10 ranges. (Chain Search)
 - You can select or deselect the search range freely by pressing the corresponding number with the keypad.
 - The scanner automatically increases its search speed from 100 to 300 steps per second for the bands having 5 kHz steps. (Turbo Search)
 - After you have set the search range through the Menu the first time for a range, you will be able to set new ranges for the same range by using the keypad and the standard direct entry method.
 - Searching feature is applied to Control Channel Only mode (see page 73).

Caution: After you have entered the search range while still in the Menu mode, you can set your alpha tag (see page 28), change the step size of the search, change the mode or change the trunk set. Once the lower and upper parameters of your search are edited, the Menu screen backs up one level to allow you to modify the step size, receive mode, and alpha tag. Select **2: STEPS** for your step size choices and then press **E**. Select **3: MODE** for the receiver mode choices and then press **E**. Select **4: ALPHA TAG** to enter an alpha tag using the **VFO** and then pressing **E**. Select **5: TRUNK** to switch ON or OFF for trunk search.

Starting Chain Search

1. After setting the search ranges, select **2: SERVICE OPTION / :CHAIN SEARCH / 1:CHAIN SEARCH** by rotating the **VFO** and pressing **E**.
2. Select **1: ON** by rotating the **VFO** and pressing **E**.
3. Press **SEARCH** to search up to 10 ranges continuously.

Note:

- If **CHAIN SEARCH** is **OFF**, only 1 range can be searched.
- When searching stops, press **RSM** to resume searching.
- When you rotate the **VFO** while searching, you can change the search direction to up or down.
- When searching in WFM, it will stop before reaching the desired frequency if the step is other than 50 kHz or 100 kHz.

Search Hold Feature

1. Press **HOLD/MAN** at anytime to stop the search.
2. Press **RSM** or **SEARCH** to resume searching.

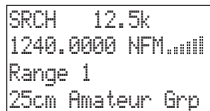

SRCH 12.5k
1240.0000 NFM.....
Range 1
25cm Amateur Grp

Data Skip

A scanner will normally stop on any transmission it receives. This means the BC250D will occasionally stop on data signals and unmodulated transmissions. You can automatically skip many of these types of transmissions during search. To activate the Data Skip feature, enter into the Menu mode.

1. Press **MENU/BACK**.
2. Select **3: SYSTEM OPTION / 7: DATA SKIP** by rotating the **VFO** and pressing **E**.
3. Select **1: ON** by rotating the **VFO** and pressing **E**.

SYSTEM OPTION
5: PC CONTROL
6: CLONE
7: DATA SKIP

When Data Skip is active, your scanner may pause momentarily on an unwanted signal but will resume searching in 2 or 3 seconds. The Data Skip feature is active as well as Scan mode and Service Search mode. Data Skip does not function during AM/WFM band Scan, Chain Search for AM/WFM band, or WX Search, Priority Scan, and Trunking mode.

Frequency Skip

If a particular frequency continues to interrupt search scanning, it is possible to set your scanner to skip the frequency.

To skip over a frequency, press **L/O** when stopping at the frequency you want to skip or when in Search Hold mode.

Note: • You can program up to 200 skip frequencies. The 201st skip frequency entered causes the first skipped frequency to unlock.

- If all frequencies in the search range are set to skip, a beep sounds and it moves to Search Hold mode.

To resume searching:

- 1) Cancel the Frequency Skip set.

— OR —

- 2) Reset the Search Frequency range.

To cancel all skipped frequencies, press and hold **L/O** for 2 seconds in Search Hold mode.

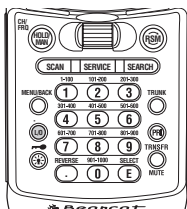

Storing Search Frequencies

You can quickly store any frequency you find during Search.

1. During Search, press **HOLD/MAN** to store or when the scanner stops on the frequency you want to store.

2. Press **TRNSFR** to store the frequency in the channel you selected. The smallest empty channel number flashes on the display. If necessary, you can also change the channel by scrolling the **VFO**.

```
SRCH 12.5k
1240.0000 NFM.....
Range 1
C004 0000.0000
```

3. Press **E**.

- Note:**
- If the frequency you want to store exists already, **WARNING** appears on the display and you will hear a beep. (See “Duplicate Frequency Alert” on page 27.)
 - After storing the frequency, it moves to the Search Hold mode.
 - In case there is not a free channel, the frequency you want to store will automatically be stored in the previous channel before you entered into Chain Search mode.
4. Repeat steps 1, 2 and 3 after starting the search for all the search frequencies you want to store.

Auto Storing

The scanner automatically stores active frequencies if Auto Store feature is turned ON.

But the frequencies already stored can not be stored.

To make use of this feature, set a search range first (see page 37), then enter into the Menu mode. If you start this feature without setting a search range, **NO LIMIT DATA** appears on the display.

1. Press **MENU/BACK**.
2. Select **1:SERVICE OPTION / :CHAIN SEARCH / 6:AUTO STORE** by rotating the **VFO** and pressing **E**.
3. Select **1:ON** by rotating the **VFO** and pressing **E**.
4. Select the bank number you want to use with the keypad. The selected bank number appears on the display.

```
AUTO STORE
SELECT BANK
12--56----
```

- Note:** If the selected bank has no free channels to store, **CH DATA FULL** will appear on the display and you will hear a beep.

```
AUTO STORE
ERROR
CH DATA FULL
```

- Press **SEARCH** to start auto storing.
- After the search has gone through the search range, press **HOLD/MAN** to stop this feature. **STORE END** appears on the display. You may want to let it run through the search range several times because during the first pass there may not have been any transmissions at that particular time on that frequency.

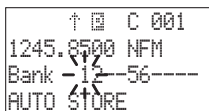

Squelch (SQ) Mode

The scanner can be set to the following SQ modes.

- **Carrier SQ mode (default setting)**
The scanner will stop on any transmission or squelch opening, regardless of whether any subaudible tone has been programmed for the channel or search range.
- **Tone SQ mode**
The scanner will stop on any active frequency for which either no subaudible tone has been programmed or for which the user-programmed subaudible tone is also active.
- **Tone Search mode**
During any transmission, the scanner will begin searching all possible subaudible tones, one of which may also be in use. The scanner counts up through the CTCSS tones and instantly determines any possible DCS tone. See page 101 for a listing of the tones that the BC250D decodes.

Note: When Tone Search is active in Scan mode, once the **CTCSS** or **DCS** display flashes a tone repeatedly (meaning that it has found the tone match), you can press **E** to program that frequency with the captured tone. When you change the mode to Tone SQ from Tone Search that frequency and tone will be programmed.
- **Tone Lock (out) mode**
For either a Memory channel or a Search Range, you can lock a particular subaudible tone by pressing **L/O** after scrolling to the desired tone. The scanner will stop on any transmission except those which may be using the locked subaudible tone.

To set your scanner, enter into the Menu mode.

- Press **MENU/BACK**.
- Select **3:SYSTEM OPTION / 8:SQ MODE** by rotating the **VFO** and pressing **E**.

3. Rotate the **VFO** to select one type (1:CSQ, 2:TONE SQ, 3:TONE SEARCH) and press **E**.
4. To set Tone Lock mode, do the following first, then select 2:TONE SQ in step 3.
 - 1) For Scan mode, select 2:SCAN OPTION / 1:CONVENTIONAL - select the channel number - 3:TONE DATA - 1:CTCSS or 2:DCS by rotating the **VFO** and pressing **E**. With CTCSS or DCS, Tone Lock ON is set by pressing **L/O**.
 - 2) For Search mode, select 1:SERVICE OPTION / 3:CHAIN SEARCH / 5:TONE DATA / 1:CTCSS or 2:DCS by rotating the **VFO** and pressing **E**. With CTCSS or DCS Tone Lock ON is set by pressing **L/O**.

- Note:**
- To set Tone Lock OFF for either Scan mode or Search mode, press **E** instead of pressing **L/O** on step 1) or 2) above.
 - CTCSS: Continuous Tone Coded Squelch System.
 - DCS: Digital Coded Squelch.
 - For example, the scanner shows the following displays. When Search mode and Tone Search are selected, the display shows the frequency and tone data alternately.

```

  [ ] C 001
512.0000 NFM
CTCSS 250.3
Bank 1
  
```

Tone SQ ON,
CTCSS 250.3 Hz
setting

```

  [ ] C 001
512.0000 NFM.....
DCS 025
Bank 1
  
```

Tone SQ ON,
DCS 025 setting

```

  [ ] C 001
512.0000 NFM.....
Bank 1
  
```

Tone SQ ON,
CTCSS & DCS
non-setting

```

    C 003
512.0000 NFM.....
- CTCSS 250.3 -
UNIDEN Group A
  
```

Tone Search,
CTCSS 250.3 Hz
detecting

```

    C 003
512.0000 NFM.....
- DCS 025 -
UNIDEN Group A
  
```

Tone Search,
DCS 025 detecting

```

    C 003
512.0000 NFM.....
UNIDEN Group A
  
```

Tone Search,
no signal received

- If the Delay feature has been set while in Tone Search mode, it resumes scanning after a 2 second delay.

Additional Menu Options for Searching

Each of these additional menu options applies to all search ranges entered. If there is a range that you do not want an option to apply, then simply enter the range number on the numerical keypad. You will see the range number that you have selected disappears from the display. (For more information on these options refer to the "Menu Descriptions" section and "Additional Features" section.)

Options:

ATTENUATOR (for more information see page 32).

1. Press **MENU/BACK**.
2. Select 1:SERVICE OPTION / :CHAIN SEARCH / 4:ATTENUATOR by rotating the **VFO** and pressing **E**.
3. Select 1:ON by rotating the **VFO** and pressing **E**.

DELAY

Refer to page 32.

Service Search

The Service Search feature allows you to scroll through the following twelve preprogrammed services. The frequencies selected for these services are the most commonly used around the U.S.

- 1: WEATHER
- 2: PUBLIC SAFETY
- 3: NEWS
- 4: TV BROADCAST
- 5: HAM RADIO
- 6: MARINE
- 7: RAILROAD
- 8: AIR
- 9: CB RADIO
- 0: FRS
- : RACING
- : SPECIAL

1. Press **SERVICE**.

— OR —

Another method is as follows:

To set Service Search, enter into the Menu mode.

1. Press **MENU/BACK**.

2. Select 1: SERVICE OPTION by rotating the **VFO** and pressing **E**.

SERVICE OPTION
1: WEATHER
2: PUBLIC SAFETY
3: NEWS

2. To start the Service Search, select one Service Search menu you want from the lists above by rotating the **VFO** and pressing **E** or directly enter the number listed above.

Note: When you start Service Search by pressing **SERVICE**, you can start Service Search without pressing **E**.

3. After a 3 second delay, searching begins for the selected service. If you want to start searching immediately, press **RSM**.
4. To change the searched service, rotate the **VFO** or directly enter the number listed above after pressing **SERVICE**.

- Note:**
- When you start searching, select **: RACING** or **: SPECIAL** by rotating the **VFO** and pressing **E**.
 - You can not change such settings as Auto Delay, during a Service Search.
 - You can enter one of the Service Search frequencies into Channel Memory by pressing **TRNSFR** when holding on one of the frequencies and pressing **E**.
 - Special Frequencies are low-power, itinerant, FRS, "splinters" and other frequencies which are

commonly used at special events and other locations and may or may not be licensed.

- When you rotate the **VFO** while the Service Search is active, you can change the search direction to up or down.

During the search of one of the preprogrammed services, the lowest display line will indicate the service that you are searching. To stop the search, press **HOLD/MAN**. Rotate the **VFO** to move up or down one programmed frequency or press **RSM** to resume searching.

Service Search Skip

You can set the scanner to skip the unwanted frequencies during Service Search. 100 skipped frequencies are programmable.

1. To skip over a frequency, press **L/O** when stopping at the frequency you want to skip.
2. To cancel a skip during search, press **HOLD/MAN**, select the desired frequency by rotating the **VFO**, then press **L/O**.

To restore all skipped frequencies, press and hold **L/O** for 2 seconds.

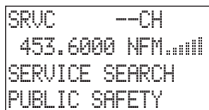

SRVC --CH
453.6000 NFM.....
SERVICE SEARCH
PUBLIC SAFETY

- Note:**
- You can not skip a set frequency in **WEATHER** service mode.
 - If you start the service searching while all frequencies in service search menu are set to skipped the frequencies, you hear a beep and the scanner moves to the Hold mode.

NWR-SAME Alert

In addition to the conventional weather broadcasts, your BC250D is compatible with NWR-SAME weather alert. When the scanner receives NOAA's Specific Area Message Encoding (SAME) coded weather emergency signal, it sounds the alert siren with a specified message. You must program your FIPS code to identify the specific area where you are located.

1. Press **MENU/BACK**.
2. Select **1:SERVICE OPTION / 1:WEATHER / 2:ALERT** by rotating the **VFO** and pressing **E**.

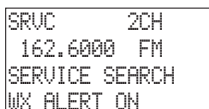

SRVC 2CH
162.6000 FM
SERVICE SEARCH
WX ALERT ON

3. Select **1:ON** by rotating the **VFO** and pressing **E**.

Note: You can also set Alert mode to OFF by pressing **RSM** without entering the Menu mode.

4. When the unit receives a warning signal, it shows a message with the alert siren defined. (For NWR-SAME EVENT CODE, see the table on page 99.)
5. To deactivate, just press any key or it is automatically canceled and the alert siren stops.

Testing the Alert Siren

To test and recognize the difference between the types of alert sirens, perform the following steps:

1. During WX Hold mode and when the WX ALT is OFF, press and hold the **PRI** key for 2 seconds until you hear the statement alert siren. **SIREN TEST** appears on the display and the statement, watch and warning sirens sound alternately.

Note: The samples of each alert siren only last for a few seconds. You may need to listen to each siren several times to be sure you recognize the different sirens. The sirens continue to sound rotating through the samples until you silence the test.

2. To stop the test, press any key.

Make sure you can hear the siren in all areas that you would need to. If not, optional accessories can be purchased to ensure that you are alerted for emergency broadcasts. See your dealer or local electronics store for accessories.

DO NOT USE EARPHONES TO LISTEN TO THE TEST. DAMAGE TO YOUR HEARING COULD OCCUR.

Programming FIPS Code

The 6-digit Federal Information Processing System (FIPS) codes established by the National Weather Service (NWS) must be programmed in your scanner. These codes specify an emergency and the specific geographic area (such as county) affected by the emergency.

1. Press **MENU/BACK**.
2. Select **1:SERVICE OPTION / 1:WEATHER / 2:ALERT** by rotating the **VFO** and pressing **E**.
3. Select **1:ON** by rotating the **VFO** and pressing **E**.
4. Select the desired memory number (**FIPS CODE 1 ~15**) by rotating the **VFO** and pressing **E**.

WEATHER ALERT SELECT CODE No. FIPS CODE 1 -----
--

When you rotate the **VFO** to move down when FIPS CODE 1 is displayed or **VFO** to move up when FIPS CODE 15 is displayed, ALL FIPS appears on the display.

5. Enter the FIPS code using the keypad.

6. Press **E**.

- Note:**
- To cancel the entry, press \ominus (decimal key).
 - To clear a stored FIPS code, press **0** and **E** successively
 - To obtain the FIPS code for your area, contact the NWS toll free at 1-888-697-7263.(1-888-NWR-SAME) or visit their web site <http://www.nws.noaa.gov/nwr/indexnw.htm>

Digital and Trunked Systems

Your BC250D is designed to monitor APCO Project 25 digital communication systems (using optional BCi25D) and tracks three major types of trunked radio systems. These systems are described here.

- ❖ **APCO Project 25 Systems** - Digital systems which support the APCO Project 25 protocol developed by the Telecommunications Industry Association (TIA) and Electronic Industries Alliance (EIA). Systems can operate in conventional, trunked (3600) and mixed-modes (analog and digital) in any frequency band including UHF, VHF and 800 MHz.
- ❖ **MOTOROLA** - Including Type I, Type II, Hybrid, SMARTNET, and Privacy Plus.
Motorola systems are widely used by public safety and business users. Most are on the 800 MHz band, and recent systems are appearing on other bands. (See page 69).
- ❖ **EDACS** - Including "Wideband" 9600 baud, and "Narrowband" 4800 baud systems.
"Wideband" systems are mostly on the 800 MHz band, and are used by public safety, utilities, and business users. Some systems are used on the VHF and UHF bands.
"Narrowband" systems are used in the 935-940 MHz band, many by utilities.(See page 64).
- ❖ **EDACS SCAT** - These systems are mainly used in the Midwestern United States and are one-channel trunking sites using the EDACS format.
- ❖ **LTR** - These systems are mostly for business users, and found on the UHF, 800 and 900 MHz bands. (See page 68).

For details on the operation and programming for all of these systems, see pages 49-79.

When tracking these types of systems, remember these important points:

- Your scanner defaults to monitor Motorola Type II systems; however, you can change this if the system in your area is different. (The types of systems are discussed below.)
- The frequencies for many of the trunked public safety systems are listed in the TrunkTracker National Public

Safety Trunked System Frequency Guide included with your BC250D scanner. Frequencies sometimes change, check with **www.bearcat1.com/free.htm**.

- If you have internet access, you can visit **scanner.uniden.com** or **www.bearcat1.com/free.htm** for additional information, for current news and frequency information, about Trunk Tracking Scanning.
- * Motorola, SMARTNET, and PRIVACY PLUS are trademarks of Motorola Inc. EDACS is a registered trademark of the M/A - COM Inc. LTR is a registered trademark of E.F. Johnson Company.

Programming and Receiving Digital and Trunked Systems

There are three steps for programming a trunked system:

1. Program the Trunk Type – What type of system will the scanner be tracking, Motorola Type II, Type I, EDACS, LTR, etc.
2. Program the Trunked Frequencies – Within a trunked system, the frequencies are shared among all the users, called “Talk Groups”.
 - Within the bank you decide which channels to program the trunked frequencies.
3. Program the Talk Groups – Within the trunked system, each agency or department is assigned a Talk Group ID. This ID must be programmed into the scanner in order to monitor that specific agency or department.
 - When programming you decide which “Location” to program the “Talk Groups”. This is similar to how you program frequencies into channels. Here you need to program Talk Group ID’s into Locations.

STEP 1:

Selecting or Changing Trunking System Type

Before using the Trunk Tracking system, you must select the bank and trunk type. You can only track one trunked system per bank, total of 10 trunked systems.

- 1 Press **MENU/BACK**.

Remember! You can also enter the Trunk Tracking Programming mode by pressing **TRUNK**.

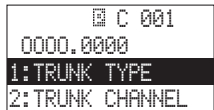

□ C 001
0000.0000
1: TRUNK TYPE
2: TRUNK CHANNEL

2. Select 2: SCAN OPTION / 2: TRUNK by rotating the **VFO** and pressing **E**.

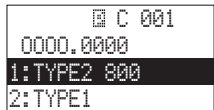

□ C 001
0000.0000
1: TYPE2 800
2: TYPE1

3. Select the bank number using the keypad or the **VFO** and pressing **E**.
4. Select 1: TRUNK TYPE / 1: ON- and the system type you want to track by rotating the **VFO** and pressing **E**.

For Type 1 System, you must enter the block and fleet numbers. Please refer to “Programming a Fleet Map” on page

71 for instructions.

STEP 1 is complete.

No.	LCD display	Icon	TrunkingType	Special requirements
1	Type 2 800	M	Motorola Type 2 800 MHz	
2	Type 1	M	Motorola Type 1	a. Must program a fleet map.
3	Type 2 900	M	Motorola Type 2 900 MHz	
4	Type 2 UHF	M	Motorola Type 2 UHF	b. Must program base, spacing, frequency and offset channel.
5	Type 2 VHF	M	Motorola Type 2 VHF	
6	EDCS WIDE	E	EDACS Wideband 9600 baud	c. Must program frequencies in exact order and location.
7	EDCS NARROW	E	EDACS Narrowband 4800 baud	
8	EDCS SCT.	E	EDACS SCAT	
9	LT	L	LTR	

Note: Information on APCO P-25 Systems are referred to in "APCO Project 25 Reception" on page 76.

STEP 2: Programming Trunking Frequencies

After you finish selecting the bank and trunk type you want to track, store the frequencies in the channels for your selected bank in your scanner. Remember that you can only store one trunking system in each bank.

Important: If you are programming an EDACS or LTR trunked system, you must enter the frequencies in a specific order. Check the frequency guide included with the scanner for the frequencies in your area. For additional frequencies, check the web sites listed on page 11.

1. Press **MENU/BACK**.
2. Select **2:SCAN OPTION / 2:TRUNK** by rotating the **VFO** and pressing **E**.
3. Select the bank number by rotating the **VFO** and pressing **E**.
4. Select **2:TRUNK CHANNEL** and enter the channel number by rotating the **VFO** and pressing **E**.
5. Select **1:FREQUENCY** and enter a frequency for the trunked system using the keypad and pressing **E**.
6. Enter the alpha tag and press **E**. (See page 53).
- 7 You can also change the step size in this menu.(See page 103)

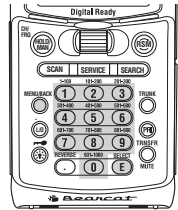

Note: • To clear a mistake while entering the frequency,

press **◊** (decimal key) twice, and the display is cleared.

- If you enter a frequency which is out of the system's trunking range, a beep sounds and **ERROR** appears on the display.

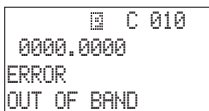

- If you enter a frequency which has been stored in another channel, you will hear a beep and the channel stored displays **WARNING** (Refer to “Duplicate Frequency Alert” on page 27).

STEP 2 is complete.

STEP 3: **Programming ID Scan Lists Manually**

Scan Lists

Each bank of your BC250D can be a trunk tracking bank and it can be a conventional scanning bank. When you designate a bank as a trunking bank, your scanner sets up 10 Scan Lists, which are simply lists used to store your favorite Talk Group IDs. Each list can contain up to 10 IDs, so you can store a total of 100 IDs for each trunk tracking bank. (1000 if you use all the banks as trunking banks!)

Scan Lists help you organize the trunking system users into categories. For example, you might use List#1 for police IDs, List#2 for fire department IDs, List#3 for emergency medical service IDs, etc. Once IDs are stored in lists, you can scan them like you scan conventional frequencies and you can lockout any one (up to 9) of the 10 scan lists by pressing the corresponding numeric key. When an ID is active, the scan list number will appear on the display. You can program your Scan Lists either manually or during Trunking Search mode.

Check the web site www.bearcat1.com/free.htm for a complete list of talkgroups for your area that you can program into your Scan Lists.

In order to program Talk Group ID's, you must first complete Step 1 – “Selecting or Changing Trunking System Type”, page 49 and Step 2 – “Programming Trunked Frequencies”, pages 50-51.

1. Press **MENU/BACK**.
2. Select **2: SCAN OPTION / 2: TRUNK** by rotating the **VFO** and pressing **E**.
3. Select the bank number by rotating the **VFO** and pressing **E**.

- Select 3: TALK GROUP by rotating the **VFO** and pressing **E**.
- Select the ID location by rotating the **VFO** or using the keypad and then press **E**. You decide which location you want to place the Talk Group ID. (The first number represents the Scan List number and the second number represents the Memory Location number.) (Direct entry method example: enter "1-5" by pressing 1, \ominus (decimal key), 5.)

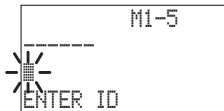

- Select 1: ID by rotating the **VFO** and pressing **E**.

7. Enter the ID.

Note: After you have programmed the ID in a selected location, while still in the Menu mode, you can set your Alpha Tag (see page 28), or turn ON the Beep Alert for an individual talkgroup (see page 22).

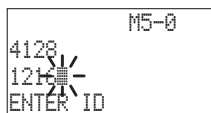

To enter a Type 2 Talk Group ID:

- Enter the ID you want to store.
- Press **E**.

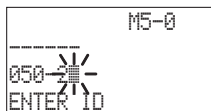

To enter a Type 1 ID:

For a Type I ID, the block number, Fleet number and Subfleet number make up the talk group ID number. Please see page 98.

- Enter the ID you want to store. (ID= Block number + Fleet number + \ominus (decimal key) + Subfleet number)
- Press **E**.

To enter an EDACS® ID:

- Enter the ID you want to store.
Use the \ominus (decimal key) for the "dash".
- Press **E**.

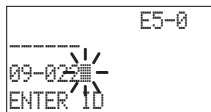

Hint: Remember that Uniden's AFS format allows you to enter full or partial EDACS IDs for powerful flexibility in all modes. Be sure to read the section "EDACS Reception" on page 64 to learn how this works.

Note: The BC250D default to "AFS" talkgroup displays for EDACS® only.

To enter a LTR ID:

For a LTR ID, the Area Code, Home Repeat number and ID make up the talk group ID. Please see page 68 for more information.

1. Enter the Area Code and then press \odot (decimal key)
2. Enter the Home Repeater number and then press \odot (decimal key).
3. Enter the ID you want to store.
4. Press **E**.

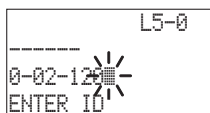

Note: To clear a stored ID while entering an ID, press **0** and **E** successively, and start over.

Assigning a Text Tag to a Talk Group ID

1. Press **MENU/BACK**.
 2. Select **2: SCAN OPTION / 2: TRUNK** by rotating the **VFO** and pressing **E**.
 3. Select the bank number by rotating the **VFO** and pressing **E**. You can also enter the Bank number by using the keypad bank.
 4. Select **3: TALK GROUP** and ID location number by rotating the **VFO** and pressing **E**.
 5. Select **2: ALPHA TAG** by rotating the **VFO** and pressing **E**.
 6. The cursor appears on the display. Rotate the **VFO** to change letters, and press **HOLD/MAN** or **RSM** to move right or left. Both capital and lower case letters are available, as well as numbers and punctuation marks.
 7. After entering the desired text, press **E**.
-  Remember! To clear a mistake while entering the letters, press **HOLD/MAN**, **RSM** or \odot (decimal key) repeatedly until the display is cleared.

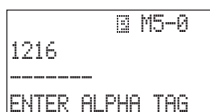

Setting the Squelch

For trunked reception, a good setting for the **SQUELCH** control is in the center of the range with the color marker pointing up. See the illustration.



If it is set too high (CCW) in some cases it could prevent your scanner from locking to the Control Channel reliably. If it is set too low (CW) it will slightly delay finding the Control Channel. The best setting is the same as for conventional reception, and is not critical.

Receiving Trunked Systems

When you have properly programmed all the frequencies for a trunked system, you can receive the system in several different ways. You will find that Search, Hold, Lockout, Scan and Delay are all similar to conventional scanning.

- ❖ ID SCAN lets you receive those talkgroups that you store in Scan Lists.
- ❖ ID SCAN HOLD lets you selectively listen to a talkgroup in your Scan Lists.
- ❖ TRUNKED SEARCH lets you hear all system talkgroup activity (unit-to-unit I-Calls may be received as well). This is the best way to get started.
- ❖ ID SEARCH HOLD works with Search mode to let you quickly freeze reception on an interesting transmission. Or you can manually specify a talkgroup with Direct Entry in ID Hold.
- ❖ ID LOCKOUT works with Search and Scan to exclude talkgroups that you don't want to hear.
- ❖ ID DELAY works with each talkgroup to be delayed for 2 seconds when the communication ends.

When receiving EDACS systems, remember that Uniden's AFS talkgroups give you powerful flexibility. In a few key presses, you can specify a single talkgroup, a fleet, or an entire agency in all the above modes. Read the section "EDACS Reception" to understand how this works.

Hint: If the scanner is not in the Trunking mode, you can enter the Trunk Programming mode by pressing **TRUNK**. Pressing **TRUNK** in the Trunking mode will move to the Scan Hold mode.

ID Scan Mode

1. Press **SCAN** to begin scanning the lists you have programmed.

If you haven't programmed more than 2 IDs, **ERROR** appears on the display.

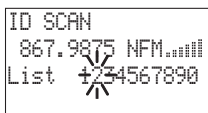

2. To remove a Scan List from active scanning, press the number of the Scan List on your keypad.

Hint: Press and hold **RSM** for 2 seconds, the scanner will move to the next trunking bank.

The Scan List indicator turns Off, and the IDs in that list are not scanned.

Note: One Scan List must always be active. If you try and deactivate all the Scan Lists, Scan List 1 will automatically be active.

3. To restore a Scan List to active scanning, press its number again.
 4. Press **SEARCH** to return to Trunk Tracking Search mode.
- ☞ Remember! When you press and hold **TRUNK** for 2 seconds, you can switch Trunk Tracking modes (Scan or Search).

Note:

- While ID scanning, to change all trunking banks to the Service Search mode, press **SERVICE**.
- Selecting a Scan List is also possible in the Menu mode. (LTR only)
- **ID SCAN** appears on the display during Trunk Scan instead of simply **SCAN**.

ID Scan Hold Feature

If you want to stop on a ID during ID scanning, press **HOLD/MAN**.

If you want to resume scanning, press **RSM**.

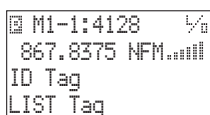

M1-1:4128 1/4
867.8375 NFM...
ID Tag
LIST Tag

To directly access a specific channel:

There are several ways to access a specific ID quickly.

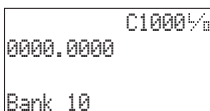

C1000 1/4
0000.0000
Bank 10

1. Press **HOLD/MAN**.
2. By using the keypad or rotating the **VFO**, enter the ID location number (See page 51).
3. Press **HOLD/MAN** again.



Trunked Search

Once you have programmed all the frequencies for a trunked system, Search will let you immediately start hearing transmissions.

Press **SCAN**, and select the bank(s) you wish to receive, just as you select banks in conventional scanning and ID scanning.

Hint: Press and hold **RSM** for 2 seconds, the scanner will move to the next trunking bank.

Talkgroups display differently in Motorola, EDACS and LTR systems. You should read the appropriate parts of this guide to understand the formats.

The display indicates the bank and the type of trunked system you are monitoring. You can change this to display a bank tag by using the System Option menu.

Regardless of the system, you won't know exactly who you are receiving until you listen for a while, or refer to frequency guides or internet sites such as www.bearcat1.com.

Of course, figuring out who each ID represents is half the fun of TrunkTracking.

Later, when you learn more about a system, you will want to store lists of talkgroups. Then you can scan specific agencies and users, and use the many other features your radio provides.

ID Monitor Mode

To enter Scan Hold mode for conventional system in the bank

selected for a trunked system, press **HOLD/MAN**, and the radio will seek and acquire the trunked system control channel.

ID Search Hold and Direct Entry ID Hold Mode

Just like in Conventional Search, Hold lets you pause ID Search on an interesting transmission without storing the talkgroup into memory.

If you hear an interesting ID during Search mode, and want to continue listening to it --

- Press **HOLD/MAN** to stop the search.

If you want to listen to a specific ID, while in Hold mode --

- Use the keypad to enter the ID you want and press **SCAN, RSM** or **SEARCH** (**SEARCH** key can not be used for EDACS).

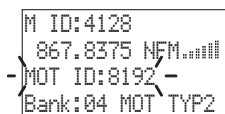

M ID:4128
867.8375 NFM...
-MOT ID:8192-
Bank:04 MOT TYP2

If you want to resume searching --

- Press **RSM** to return to Search mode.

Note: ID Hold feature is also applied to ID Scan mode.

ID Lockout

Like conventional scanning, it's possible to lockout unwanted traffic. This is particularly important in trunked systems because in many areas, water meters, door alarms, traffic signals, and other mechanical devices are assigned IDs just like other users. Also some departments scramble or encumber their communications, and you may want to lock out these unintelligible broadcasts.

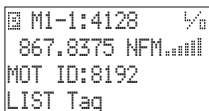

M1-1:4128
867.8375 NFM...
MOT ID:8192
LIST Tag

To Lockout an ID, press **L/O** when the ID you want to lockout displays.

The ID is locked out. You can Lockout up to 200 IDs.

Note: If you Lockout an ID in Search mode, it is also locked out in Scan List mode.

Conversely, if you Lockout an ID while in Scan List mode, it is locked out in Search mode. For information about Scan Lists see page 51.

EDACS BLOCKOUT is a powerful form of ID LOCKOUT that can be used only with AFS and EDACS systems. This feature lets you lockout entire Agencies or Fleets, not just individual talkgroups. Using ID BLOCKOUT you can, for example, prevent Search from stopping on any of hundreds of

talkgroups in the Utilities agency. You can do this with just a few key presses. To use ID BLOCKOUT just enter the Agency- part, or the Agency-Fleet part, of the talkgroup code and press **L/O**. For example, to Blockout Agency 4 in Trunk Search, press **HOLD/MAN, 0, 4, .** (decimal key), and then **L/O**. For other ways to use partial AFS entry, be sure to read the section "EDACS Reception".

Review ID Lockout

You can check all IDs already locked out.

1. Press **MENU/BACK**.

— OR —

1. When you press and hold **L/O** for 2 seconds in trunking, you can also check all IDs locked out.
2. Select **2:SCAN OPTION / 2:TRUNK** by rotating the **VFO** and pressing **E**.
3. Enter the bank number using the keypad and pressing **E**.
4. Select **6:L/O ID REVIEW**.

L
LT ID:0-02-042
L/O ID REVIEW

Restoring Locked-out IDs

To unlock a single ID, follow these steps:

1. Press **MENU/BACK**.
2. Select **2:SCAN OPTION / 2:TRUNK** by rotating the **VFO** and pressing **E**.
3. Select the bank number by rotating the **VFO** and pressing **E**.
4. Select **6:L/O ID REVIEW** and the locked out ID you want to unlock by rotating the **VFO**.
5. Press **L/O**. The ID is unlocked and the next locked ID displays.

To unlock all locked out IDs in a bank once:

1. Press **L/O** for 2 seconds after selecting **6:L/O ID REVIEW** in step 4.

Reverse Key

For Motorola and EDACS system; to change your display between the Scan List indicators and trunk bank display, press **REVERSE**.



For LTR systems only, the talkgroup must be active in order to change the Scan List and bank indicators. If the talkgroup is not active, change the Scan List by using the Menu screen.

Setting the Delay Mode for Trunking Mode

The delay of 2 seconds is automatically set for each talkgroup for ID Scan mode and ID Search mode. To set the delay feature, enter into the Menu mode.

1. Press **MENU/BACK**.
2. Select 2:SCAN OPTION / 2:TRUNK by rotating the **VFO** and pressing **E**.
3. Select the bank number by rotating the **VFO** and pressing **E**.
4. Select 4:DELAY and pressing **E**.
5. Select 1:ON or 2:OFF by rotating the **VFO** and pressing **E**.

Note: If you want to verify the Delay mode setting, press and hold **MENU/BACK** for 2 seconds in Trunking mode.

Setting Priority in Trunking Mode

You can set priority in your trunking lists, just as you do in your conventional ones. You can set the priority by pressing and holding **PRI** for 2 seconds in ID Scan Hold mode.

After you've set up your Scan List, press **PRI** to activate it.

It's very similar to conventional priority although there is no "interrupt" during the transmissions. Priorities are checked in between transmissions.

With Priority ON, you can hold on an ID in your Scan List, such as Scan List 6, memory position 7, and the scanner will check all the priorities in all the active Scan Lists in between any transmissions on the ID on which you're holding. The lowest numbered priority will be checked first. For example, the Priority ID in List 1 will be checked before the Priority in List 2, etc.

Note: This function does not work in LTR tracking.

Programming Scan Lists During Search

To select a Scan List location and store an ID during Search mode, follow these steps:

1. When your scanner stops on an ID you want to store, press **HOLD/MAN**.

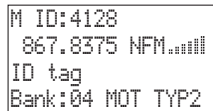

```
M ID:4128
867.8375 NFM
ID tag
Bank:04 MOT TYP2
```

2. Press **TRNSFR** and the smallest empty Scan List appears on the display, then press **E**. In case you want to change the memory location, you can change it by rotating the **VFO**.

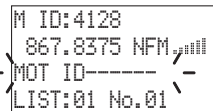

```
M ID:4128
867.8375 NFM
MOT ID
LIST:01 No.01
```

3. Press **RSM** to return to Trunk Tracking Search mode.

Deleting a Stored ID

To delete a stored ID:

- a. Press **HOLD/MAN** in the ID Scan mode.
- b. Rotate the **VFO** to select the Scan List location you want to delete.
- c. Press **0**.
- d. Then press **E**.

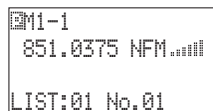

```
M1-1
851.0375 NFM
LIST:01 No.01
```

Moving between Scan List Memories

There are a number of ways to step and move through your Scan List memories:

1. Press **HOLD/MAN** in the ID Scan mode and rotate the **VFO** to move to up or down.
2. Or, press **HOLD/MAN** in the ID Scan mode, next press **0-9** (scan list number), then press **0-9** (memory position). For example to move to Scan List 4, memory position 10, press: **HOLD/MAN, 4, 0, HOLD/MAN**

Set Activity ID to ON, when your scanner finds an active ID during a transmission the active ID appears every 0.5 seconds.

I-Call (Motorola/EDACS)

I-Calls are direct unit-to-unit transmissions that are not heard by other system users. Your BC250D can receive these transmissions. How you receive I-Calls depends on whether you are in Search or Scan mode.

During I-Call reception the display will show the Unit ID number of either the transmitting or receiving mobile unit, not a talkgroup. Unit IDs will display differently according to the type of trunked system, and will replace the n's shown here.

EDACS and MOTOROLA TYPE 1 i nnnnn

MOTOROLA TYPE 2 7 nnnnn

Hint -- There are thousands of Unit IDs in typical systems, but relatively few I-Calls at a given moment, so it is normally best to let the scanner receive any I-Calls without trying to specify particular units.

I-CALLS IN SEARCH MODE

In Search mode, the scanner default is that I-Call reception is OFF. This means that I-Calls will not be received until you program them to be ON. You have three choices for controlling I-Call reception. Through the Menu system, go to **2: SCAN OPTION / 2: TRUNK** - select bank number - / **8: I-CALL**, and make your selection.

The menu choices are:

		I-CALLs	TALKGROUPS	
1	ON	YES	Received normally	Use this choice to receive I-Calls together with normal talkgroup traffic.
2	OFF	Not received	Received normally	This is the BC250D default
3	ONLY	YES	NOT RECEIVED	Use this setting to listen to I-Calls, and block all talkgroup reception. For quick access to this mode, press  (decimal) then RSM .

You can hold any I-Call IDs. Because you can only hold on one ID, and there are two IDs involved in any I-Call communication (the transmitting and the receiving units), you might not hear the full conversation, but you probably will.

☞ In Search mode, when you hear an interesting I-Call, you can enter the instant shortcut \odot (decimal key) then **RSM** to enter I-Call Only mode. This blocks all talkgroup traffic and lets you hear just the I-Call. To return to normal reception, you must use the Menu system to select the **ON** or **OFF** option.

Note: When storing I-Call IDs, remember that the ID will be for only one of the units – either the transmitting or receiving unit. Unless you specifically want to receive a certain ID, it might be better to use the special code in the HINT below.

I-CALLS IN SCAN AND HOLD MODE

You can store I-Call IDs in Scan Lists, just like talkgroup IDs, for use by ID Scan and Scan Hold modes. To program a specific I-Call Unit ID into a Scan Lists:

EDACS or Motorola Type 1

Press \odot (decimal key) followed by the Unit ID digits, then **E**.

Motorola Type 2

Press 7 followed by the Unit ID digits, then **E**.

HINT - There is a special code to let you receive all I-Call IDs with a single Scan Lists entry. Simply press \odot (decimal key), **0**, **E**. This will store the special code $i0$ in an EDACS Scan Lists, or **7000000** in a Motorola Scan Lists or Digital. Then, whenever you Scan this entry, or select it in Hold mode, the scanner will receive any active I-Calls, regardless of the Unit IDs.

Note: Motorola I-CALL tracking performance may vary between systems.

Multi-Track

The BC250D allows you to track more than one system at a time. Here are some highlights of this feature:

- ❖ You can actually track up to 10 trunking systems at one time.
- ❖ You can trunk, scan, or search and scan conventional frequencies at the same time.
- ❖ You can program conventional frequencies in the same bank as trunking systems.

After the scanner finishes checking a trunked system for activity, it will conventionally scan the other frequencies in the bank (remember, only trunking frequencies are programmed in Trunk mode).

To scan a mix of trunking and conventional banks, select the banks you wish to be active, and then press **SCAN**. The scanner will instantly begin scanning. If you have not programmed a trunking bank with talkgroup ID's, you will receive **NO ID (-----)** message for that bank. You can switch to Search mode and the scanner will search for any active ID's on the system.

Note: To switch ID Scan or ID Search, press and hold **TRUNK** in the trunked system.

Multi-Track Operational Details

When more than one trunk system is active (for example two or more trunked systems or a trunked system and one or more conventional frequencies), the radio jumps between systems/frequencies as follows:

TRUNK SCAN: The scanner moves to a trunked system and looks for IDs in your Scan List(s) for up to 1 second. If it finds no activity on your programmed talkgroups, it moves on to conventional channels in the same bank or to the next active bank.

If the scanner finds that a talkgroup in one of your active Scan Lists, you will begin to hear that communication and the scanner will of course display the proper talkgroup number and any alpha tag. When the communication ends, the scanner will wait for 2 seconds for any further replies and, if none, the scanner will move to the conventional channels in the same bank or to the next bank. The scanner will not look for any other IDs within the same trunked system (as this would slow the scan process). If you press **RSM** while you are listening to one ID, the scanner will check to see if another ID in your Scan List is active. It will disregard the ID to which you were just monitoring.

TRUNK SEARCH: This mode works similarly to Trunk Scan. If the scanner finds any (non-locked-out) ID when it checks the control channel, you will hear it. You will then hear any replies that follow within 2 seconds. After that the scanner will move on and not continuously search the system for additional IDs (on busy systems you would never leave the system if this were the case). If you press the **RSM** key while monitoring one ID, the radio will check if any other IDs are active (it will disregard the ID you just left), and if none are active, it will move on.

EDACS® Reception

EDACS® Tracking

TrunkTracker III now allows tracking of EDACS® trunked systems. Until now these widely used systems have been almost impossible to monitor with a conventional scanner. With your TrunkTracker III listening to EDACS(s) is remarkably easy, and perhaps even easier than conventional scanning.

EDACS systems use 'Transmission Trunking', which means that each transmission is assigned a new frequency. As the conversation moves through the system's frequencies, your TrunkTracker III automatically follows it.

This chart shows a 30 second sample of EDACS transmissions. Eight different talkgroups are using the system as their transmissions switch between the thirteen system frequencies.

Notice how the dotted line shows talkgroup 02-023 moving from channel to channel. Your BC250D can clearly and automatically follow this talkgroup, or any other, as you select.

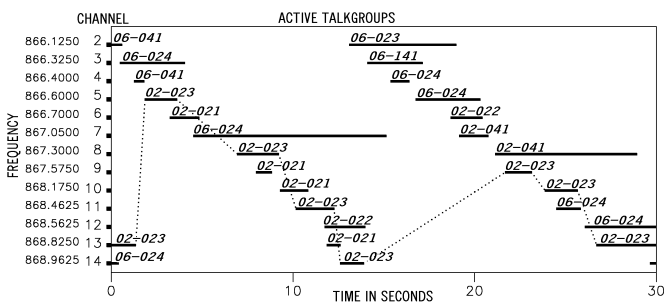

EDACS systems are organized in a logical way that keeps related talkgroups together. Your scanner is designed to take maximum advantage of this organization to make your scanning easy. It lets you zero in on just the part of the system you want to hear, whether it is an individual channel or an entire department or city.

Programming EDACS System Frequencies

When you program EDACS frequencies, it is critical that you store each one in the CORRECT LOCATION. By the nature of EDACS systems this is necessary for tracking. This often is not the frequency order, so you must be sure you have the right sequence. Sources for this information can be found at scanner.uniden.com.

An EDACS® Trunked system

This chart shows how talkgroups are organized within an EDACS system at the Agency level. The individual talkgroups cannot be shown at this scale because there are over 2000. However the chart can show the 16 Agencies in this example. The system is logical and easy to understand. EDACS systems are typically arranged in an outline structure.

The system users are given blocks of talkgroups. Sizes vary but most large cities and other agencies have blocks of 128 channels. Smaller cities have only 64 or 32 channels.

In this example, the County Sheriff is agency 01. The city of Sullivan is Agency 03. Adams Hill and Matthew Junction share Agency 08.

Your scanner shows EDACS talkgroups in AFS (Agency-Fleet-Subfleet) format. This helps you see, at a glance, who you are monitoring. And with the partial-entry feature you can easily include nearby, related channels in the same Fleet or Agency. You can just as easily exclude entire unwanted Fleets and Agencies.

When in Search mode, with the system frequencies programmed, and your scanner locked to the control channel, you can select a desired city by keying in the Agency part of the AFS talkgroup. For example, you can select the entire city of Sullivan with 4 key presses **0, 3, 0** (decimal key), **SEARCH**.

When you hear an interesting talkgroup, capture it to your Scan List by pressing **TRNSFR** and **E** during the transmission.

Or hold on it by pressing the **HOLD/MAN** key.

If you want to monitor the Sullivan Police Dispatch channel (which is talk group 03-062), press **0, 3, 0** (decimal key), **0, 6, 2, RSM** or **SCAN**.

Your scanner can also work in decimal format.

This talkgroup in decimal format is 434. But decimal format does not give you any information about the system hierarchy.

AFS	AGENCY	DECIMAL
00		000
01	COUNTY SHERIFF	100
02	HOSPITALS COUNTY FIRE AMBULANCE	200
03	SULLIVAN	300
04	SWANSON BIRMINGHAM	400
05	MILLIKEN RANORA POND TROUBLE CREEK	500
06	COLUMBIA	600
07		700
08	ADAMS HILL MATTHEW JCT	800
09	CLIFFORD	900
10	COUNTY GOVT	1000
11	BEACONSFIELD	1100
12	NEW ELFERS BRENNAN EXMORE OAK VALLEY	1200
13	MIRANDA CANYON	1300
14		1400
15		1500
		1600
		1700
		1800
		1900
		2000

For example Sullivan, in decimal, uses channels from 384 to 511. This is not as easy to remember as Agency 03. But decimal is useful if you need to work from decimal talkgroup lists. To turn Emergency Alert ON/OFF, enter into the Menu mode. Select 2:SCAN OPTION / 2:TRUNK -select bank number-9:EMERGENCY ALT / 1:ON or 2:OFF by rotating the **VFO** and pressing **E**.

Special EDACS® Features

AFS Partial Entry Feature

AFS is Uniden's method of encoding EDACS talkgroups. AFS stands for 'Agency-Fleet-Subfleet'.

AFS talkgroups are used in all EDACS reception -- in ID Search, ID Lockout and ID Scan Scan Lists. The powerful AFS Partial Entry feature designed into the BC250D lets you use either a complete talkgroup code, or just the most significant part.

This feature lets you expand or narrow searching and scanning to one of 4 levels. By entering only the desired part of an AFS talkgroup, you can select 2048 talkgroups, 128 talkgroups, 8 talkgroups, or a single talkgroup.

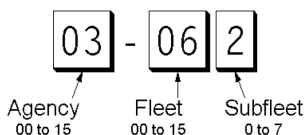

For example, you could program every talkgroup in a police department with just 4 key presses. You can use the AFS Partial Entry feature anywhere that you need to specify EDACS talkgroup.

Your BC250D can also enter or display EDACS talkgroups in decimal format (0-2047).

Select 2:SCAN OPTION / 2:TRUNK - select Bank number - / 0:EDCS ID FORM by rotating the **VFO** and pressing **E**. And change it to 2:DECIMAL and press **E**. You can use this feature to translate decimal talkgroups lists to the much more powerful AFS format.

Examples of how you might use AFS are shown above in the description of an EDACS trunked system, and elsewhere in this manual. It is very easy to use. Be sure to become familiar with AFS Partial Entry, and your scanning will become far more flexible and efficient.

Emergency Call Alert

Your BC250D alerts you when an EDACS Emergency transmission occurs.

EDACS systems often provide users with an 'Emergency' mode on their radios. Users in trouble can alert the dispatcher and other units and get priority access to the radio system. When a user activates Emergency mode, EMERGENCY will flash the display during the entire transmission. At the beginning of each transmission it will sound a distinctive emergency alert tone three times. To turn Emergency Alert ON/OFF, enter into the Menu mode. Select 2:SCAN OPTION / 2:TRUNK - select Bank number - 9:EMERGENCY ALT / 1:ON or 2:OFF by rotating the VFO and pressing E.

Patch Tracking

The BC250D can follow EDACS patched talkgroups.

EDACS systems sometimes bring several talkgroups together in a 'Patch'. A patch might be used by a police agency at night to provide a single channel with a single dispatcher for a wide area. A patch is created when a single, temporary talkgroup substitutes for the original talkgroups. While the patch is running, which may be for hours or days, the original talkgroups cease to be used. If you were monitoring one of these talkgroups, you might think there was no traffic, but in fact the talkgroup was operating at the different temporary number.

If a talkgroup in your Scan List is patched, your scanner will continue to receive it under its new identity until the patch has ended. When a patch is being received, the radio will display PATCH ID, and will show the temporary common talkgroup plus all the included talkgroups in a cycling display. The BC250D is limited to following two patches.

The temporary talkgroups used for patches are usually found in AFS code 15-xxx, and sometimes 00-xxx.

EDACS SCAT

With the EDACS SCAT feature turned "ON", the data stream transmissions will be eliminated allowing you to clearly monitor the voice communications on EDACS SCAT systems.

To monitor EDACS SCAT systems you only need to turn this feature 8:EDCS SCT. ON with designated frequency. You do not need to enter group ID's.

Note: As EDACS SCAT is different from the other tracking feature, and it is not a feature which the scanner tracks any ID, you do not need to program Talk Group ID in the Menu mode.

LTR[®] Reception

LTR[®] Tracking

LTR[®] (Logic Trunked Radio) systems are trunking systems used primarily by business or private communications service providers, such as taxicabs, delivery trucks, and repair services. These systems encode all trunking information as digital subaudible data that accompanies each transmission. Users on an LTR system are assigned to specific talkgroups, which are identified by the radio as six digit numbers. These numbers are in the form AHHUUU, where:

A= Area code (0 or 1)

H= Home repeater (01 through 20)

U= User ID (000 through 254)

When the scanner receives a transmission on a channel set to the LTR mode, it first decodes the LTR data included with the transmission. In the ID Search mode, the scanner stops on the transmission and displays the talkgroup ID on the display. In the ID Scan mode, the scanner only stops on the transmission if the LTR data matches a talkgroup ID that you have stored in the bank's talkgroup ID list and have not locked out.

LTR systems are frequently programmed so that each radio has a unique ID code.

Motorola Reception

Motorola Tracking

There are really two types of Motorola trunking systems. These are usually referred to as Type I and Type II systems. Type I only occurs on some 800 MHz systems. All VHF, UHF and 900 MHz trunking systems use Type II.

One important distinction between these two systems is the amount of data transmitted by each radio when its push-to-talk button (**PTT**) is pressed. Every radio in a trunked system is assigned a unique ID so the central site computer can identify it when it's used. Both Type I and Type II systems place radios (or radio users) into groups, called talkgroups, and these talkgroups are also assigned unique IDs. Some radios have access to only one talkgroup, while others have access to many talkgroups. The talkgroup(s) each radio can access is called the radio's affiliation(s).

In a Type II system, when someone uses their radio, only the radio ID is transmitted when **PTT** is pressed, whereas in a Type I system the radio ID and its current affiliation are both transmitted when **PTT** is pressed.

Why the difference? Type II systems are slightly more advanced because the central computer maintains a database which is used to determine each radio's affiliation(s).

Changes to a Type II system are easier than Type I because the system manager only needs to update the database instead of reprogramming individual radios.

Another difference between the systems is that Type I systems are arranged in a Fleet-Subfleet hierarchy. For example, its possible for a city using a Type I system to designate 4 Fleets, each with 8 Subfleets. Their fleets might be the Police Department, the Fire Department, Utilities, and Administration. The Police may decide to further divide their fleet into subfleets such as Dispatch, Tactical Operations, Detectives, North, South, East and West Side Patrols, and Supervisors. All the available police radios would then be assigned to one of the police subfleets. Determining the exact Fleet-Subfleet hierarchy for a particular area is referred to as Fleet Map Programming, which is discussed further in this manual.

The disadvantage of a Type I system is that when **PTT** is pressed, the brief burst of data must contain the radio's ID and its Fleet and Subfleet. This is three times the amount of data a Type II system radio sends, and as a result Type I

systems usually accommodate fewer users than Type II systems.

Even though there are many Type II systems, Type I systems are still in use. There are also Hybrid systems which are a combination of both Type I and Type II. Your scanner defaults to monitor Type II systems, but its possible to select a Preprogrammed Fleet Map or create a Custom Fleet Map for your area.

For VHF and UHF Type II trunking systems, you will need to know the base, spacing frequencies and offset channels. See page 72 for details.

Fleet Map Programming

If you have programmed a trunk tracking bank for Motorola type and press **SCAN** to start Multi-Track, you will see user IDs display on the display. Since the BC250D defaults to Type II systems, all the IDs will appear as numbers. However, if you notice a mix of odd and even user IDs, for example 6477, 2560, 6481, 6144, 1167, etc., then you are probably monitoring either a Type I or Hybrid systems. These systems are applied only when STATUS BIT is OFF (see page 73).

You may also notice that you are missing responses when you hold on an active ID. Unlike Type II, Type I/Hybrid systems require a Fleet Map that sets specific Fleet-Subfleet parameters. It is easy to select a Fleet Map for your scanner; what is not always easy is selecting or programming a map that matches your particular area.

There are 16 preset Fleet Maps listed in the appendix that you can choose, and these are usually a good place to start when setting up a Type I/Hybrid trunk tracking bank. If you choose a preset map and still have difficulty following complete conversations, then you'll have to program your own Fleet Map.

Selecting Preset Fleet Map

1. Select 2: TYPE1 for the Trunk Type. (Refer to "Selecting or Changing Trunking System Type" on page 49.)
2. Select the map you want to program by rotating the **VFO** and pressing **E**.



```

M 001
867.8375 NFM
1:TYPE2 800
2:TYPE1

```



```

M 001
867.8375 NFM
SELECT
PRESET1

```

The scanner returns to the other programming items.

Note: You will now begin to see Type I Fleet-Subfleet IDs. For example, 100-12, 100-9, 000-12, 400-8, etc. See "User Defined Fleet Maps in the Appendix" for more information about Type I IDs.

How do you know if the preset map is correct? You will have to listen to see if you're following complete conversations. If not, you should try another preset map.

Programming a Fleet Map

You may want to read "User Defined Fleet Maps" in the Appendix before programming a Fleet Map. It contains a detailed explanation of Scanner Fleet Map Programming, as well as a table listing the Fleet Map Size Codes.

1. Select 2:TYPE1 for the Trunk Type. (Refer to "Selecting or Changing Trunking System Type" on page 49.)
2. Select USER CUSTOM by rotating the **VFO** and pressing **E**.
3. Select the size code for the first block by rotating the **VFO**.
4. Press **E**.
The next available block displays.
5. Repeat step 3 and 4 until you have selected a size code for each block. For details about each size code, see "Fleet Map Size Codes" in the Appendix.

```
      [ M 001
867.8375 NFM
1:TYPE2 800
2:TYPE1
```

```
      [ M 001
867.8375 NFM
SELECT FLEET MAP
USER CUSTOM
```

```
      [ M 001
867.8375 NFM
BLOCK 0
SIZE CODE 0
```

Programming a Hybrid System

A Hybrid system is simply a Type I system with some blocks designated as Type II blocks. To program a Hybrid system, follow the steps listed in "Programming a Fleet Map" in the previous section. However, if you want a block to be Type II, select Size Code S-0.

When you begin searching a trunking bank with a Hybrid Fleet Map, you will see both types of system IDs. That is, Type II IDs usually appear as an even number without a dash; Type I IDs appear as a three or four digit number, followed by a hyphen, followed by a one or two digit number.

Setting the Base, Spacing Frequencies and Offset Channel for Motorola VHF/UHF Trunked Systems

To properly track Motorola VHF and UHF trunked systems you must enter what is known as the base, the spacing frequencies and offset channels for each system.

To find these out, check the scanner.uniden.com or www.bearcat1.com/free.htm and other web sites and frequency resources.

To enter the Base, Spacing Frequencies and Offset Channel: (You can set up to three sets of these, but almost all systems only use one set)

1. Press **MENU/BACK**.
2. Select 2: SCAN OPTION / 2: TRUNK by rotating the **VFO** and pressing **E**.
3. Select the bank number by rotating the **VFO** and pressing **E**.
4. Select 1: TRUNK TYPE / 1: ON / 4: TYPE2 UHF or 5: TYPE2 UHF by rotating the **VFO** and pressing **E**.

5. Select BASE CONFIG from 1 - 3 by rotating the **VFO** and pressing **E**.

```
M
406.0000
ENTER FREQUENCY
BASE FREQUENCY 1
```

6. Enter a new Base Frequency with the keypad.

7. Press **E**.
The display changes for entering the Spacing Frequency.

```
M
50.0
ENTER FREQUENCY
SPACE FREQUENCY1
```

8. Enter a new Spacing Frequency with the keypad.

Note: You can only enter within a range of 5-100 kHz, and 5 or 7.5 or 12.5 kHz multiples.

9. Press **E**.
The display changes for entering the Offset Channel.

10. Enter a new Offset Channel with the keypad. The Offset Channel for the first set should be CH380.

```
M
CH 380
ENTER CHANNEL
OFFSET CHANNEL1
```

Note: You can only input within a range of 380-759.

11. Press **E**.
The display changes for entering the Base Frequency.

12. To exit from this mode, press **MENU/BACK** repeatedly.

- Note:**
- If the system is not tracking properly, you may need to try a new Base Frequency or Offset Channel or you may be missing frequencies from the system.
 - You can set up to three Base, Spacing and Offsets for Motorola VHF/UHF trunked systems.

Toggling the Status Bit

On Type II trunking systems there is a method by which specialized types of communications utilize unique talkgroup numbers. An emergency call will occur on a unique talkgroup from its primary assignment, for example. Because the BC250D defaults to Status-Bit ON mode, you never need to worry about missing these transmissions. If you have programmed talkgroup 33264 into Scan List memory, for example, and there is an emergency call within the group, you will hear it on 33264.

The only time you may wish to turn Status Bits OFF is if you're trying to figure out the proper Fleet Map of a Type I trunking system. To turn Status Bits OFF, enter into the Menu mode and select `2:SCAN OPTION / 2:TRUNK` - select bank number - / `9:STATUS BIT`. (This feature does not apply to EDACS and LTR operation within the scanner.) Then rotate the **VFO** to change the setting (`1:ON` to `2:OFF`) and press **E** to program your change.

Control Channel Only Mode

When this function is activated, trunking is performed using Control Channel data only. Voice channel (also known as "DATA channel") frequencies do not have to be programmed into memory. This feature only applies to Motorola 800 MHz and 900 MHz systems.

To turn this function on, choose Motorola `1:TYPE2 800` or `3:TYPE2 900` or `2:TYPE1` in the Menu mode. Then set to the desired control plan by selecting `2:SCAN OPTION / 2:TRUNK` - select bank number - / `:CNTRL CH ONLY`.

You must choose one of 4 frequency plans (only when 800 MHz systems is selected) before you begin to Control Channel Trunk. The default, Plan 1, is the most common. Read the description of the Plans below for details on which may apply for you.

PLAN 1: Use Plan 1 if the last three digits of ALL the frequencies in use end in one of the following three digits: 125, 375, 625, or 875 (example: 856.1125, 860.7375, 859.6625, 855.8875).

PLAN 2: If the last three digits of frequencies are less than 869.0000 and end in one of the following three digits (125, 375, 625, or 875) and if ANY other frequencies end in (000, 250, 500, or 750) use Plan 2.

PLAN 3: If the last three digits of ALL the frequencies in use end in one of the following three digits (000, 250, 500, or 750) use Plan 3.

PLAN 4: If the last three digits of frequencies are less than 866.0000 and end in one of the following three digits (000, 250, 500, or 750) and if ANY other frequencies end in (125, 375, 625, or 875) use Plan 4.

Of course you will know the Control Channel frequency itself so that will help you determine the proper plan. If you try one plan and you receive errors (such as the scanner jumping to channels that are obviously not part of the system), you should try an alternate Plan.

Note: In Chain Search mode, Control Channel Trunk is activated in the Menu mode (See page 18). You must choose one of 4 frequency plans. This plan applies only when the scanner searches the 800 MHz range. Since a default plan is automatically used when the scanner searches the 900 MHz range, a user does not need to select a plan.

Note: You can assign a Fleet Map to TYPE 1 or Hybrid systems scanned in Control Channel Only mode by going into the Menu. You can also program IDs, set a delay, alpha tags and all the other parameters for systems scanned in this mode. You can then either search the system to find new IDs or you can program IDs into memory and then scan them.

Note: The Control Channel Only feature is an extremely powerful tool. You can use it to determine if systems you are familiar with may have added new frequencies or you can use it to discover new systems by simply finding active control channels (using Search) and then programming them for Control Channel operation only. Remember that this feature only applies to Motorola 800 and 900 MHz systems, that you do have to set the Menu for the proper system type (800 MHz of Type 1 or Type 2 or 900 MHz) and you do have to program the Control Channel frequency into Memory.

Disconnect Tone Detect Option (End Code)

When this function is disabled, the radio looks for squelch before returning to the Control Channel instead of waiting for the Disconnect Tone. Only in rare instances will you need to adjust the default settings.

The condition to return to Control Channels depends on whether the signal is present or not.

To set this function to ON / OFF, select 2:SCAN OPTION / 2:TRUNK - select bank number - / 0:END CODE.

Select 1:DETECT or 2:IGNORE.

APCO Project 25 Reception

APCO Project 25 is a modulation process where voice communications are converted into digital communications. This conversion is similar to the technology used with digital mobile phones. There are several types of Project 25 systems available! Systems the Uniden BC250D supports are listed below.

- Conventional – one frequency with digital voice.
- Trunked with analog control channel and digital voice – Many frequencies shared by many departments and the control channel is analog with digital voice. Control channel operates at 3600 Baud.
- Mixed mode – trunked (3600) system with an analog control channel alternating / mixing analog and digital voice communications.

Note: Do not install the APCO card with the AC Adapter connected.

Installing the APCO P-25 Card

1. Turn OFF the scanner, and open the cover.
2. Carefully unplug the battery pack.
3. Insert the APCO card with the label (the side “APCO P-25 DIGITAL CARD” is printed) facing up as shown.

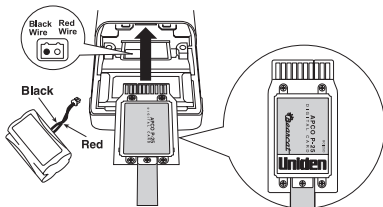
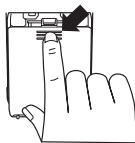

4. Carefully connect the battery pack, matching the red and black wires with the corresponding Red/Black plug.

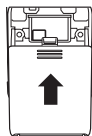

5. Replace the cover and press down until it clicks into place, and then turn ON the scanner.
APCO P25 CARD INSTALLED appears on the display.
Installation is complete. You can monitor APCO Project 25 systems.

To use the P-25 card, you must program each channel for Conventional mode or Trunking mode.

- Conventional mode—See “Storing Frequencies into Channels in Menu Mode” pages 26-27.
- Trunking mode —“Programming and Receiving Digital and Trunked Systems” pages 49-51.

Precautions for Installing the BCi25D Card

1. Do not touch the BCi25D card without first removing the static electricity from your body. To do this, touch any metal object to release static electricity build-up before you touch the BCi25D card.
2. Turn OFF the scanner, before inserting the BCi25D card into the slot.
3. Hold the BCi25D card by its edges when inserting it into the slot.
4. Do not touch any of the terminals. The BCi25D is a sensitive electrical device.
5. Do not operate with an open battery compartment cover. This exposes the circuitry to dust and other environmental particles that causes the unit to function improperly.
6. When you remove the BCi25D card, pull out the card by the ribbon.

Turning ON/OFF the APCO P-25 Card

Once the P-25 Card has been installed, the P-25 Card will be actively turned “ON”. To turn the P-25 Card “ON” or “OFF” follow these instructions:

1. Press **MENU/BACK**.
2. Select 3:SYSTEM OPTION / 0:P-25 CARD by rotating the **VFO** and pressing **E**.
3. Select 0:P-25 CARD / 1:ENABLE or 2:DISABLE by rotating the **VFO** and pressing **E** for your desired operation.

APCO P-25 Sound Quality Fine Tuning

With each APCO Project 25 system, particularly at 800MHz, the sound quality (C4FM Demodulation Threshold) may need to be fine tuned specifically for that system. If the scanner is not adjusted correctly, the P-25 voice transmissions will sound robotic or unintelligible.

To adjust the sound quality to match the P-25 system you want to monitor follow these four steps:

1. While monitoring a specific APCO P-25 frequency, press the **HOLD/MAN** key.

Note: In the Trunking mode, press the **TRUNK** key instead of the **HOLD/MAN** key.

2. Press and hold the number **9** key.
3. On Line 1 of the screen you will see SOUND QULTY: 0050 (for example).

SOUND QULTY:0050
867.8375 P25.■■■■
Low Mid Upp
0533 1985 3342

This shows the Sound Quality. The lower the level the better the Sound Quality. For better Sound Quality rotate the **VFO** up or down. As the threshold adjusts in increments of 50 at the bottom of the screen watch the Sound Quality level increase or decrease and continue to rotate the **VFO** until you have achieved the lowest Sound Quality level.

- Note:**
- When APCO P-25 signal is not received, SOUND QULTY: ***** appears on the display.
 - You must have the BCi25D card installed and have an APCO P-25 signal during this adjustment.
 - A chart showing the Threshold Adjustment Range is listed below.

Threshold Adjustment Range



Band	Lower			Mid	Upper		
	Min	Default	Max	Default	Min	Default	Max
800MHz	33	533	1883	1985	1992	3342	3842
UHF	33	633	1883	1985	1992	3342	3842
VHF	330	930	2130	2147	2264	3464	4064

- Note:**
- The above Min and Max values are the calculated values that can be

assigned theoretically, and the values are not to guarantee the operation of the unit.

- The Mid threshold value will not change while adjusting the upper and lower limits.
4. Once you have adjusted the Sound Quality to the lowest possible level, press the **E** key.

Press the **RSM** key to exit the Sound Quality Adjustment Mode.

- * To cancel the adjusted threshold level, press  (Decimal) key.
- * The adjusted threshold level for the current frequency can be set back to the default value by pressing and holding the  (Decimal) key.
- * When you change the Sound Quality it affects all other APCO P-25 signals in that same band. (UHF, VHF, or 800MHz)
- * You cannot enter the "Sound Quality Fine Tuning" mode when the scanner is operating as follows:
 - 1) The receiving frequency is 0 MHz.
 - 2) Air Band Frequency
 - 3) BCi25D card is not inserted
 - 4) BCi25D / P-25 monitoring is disabled

Remote Interface

You can communicate and program your BC250D in numerous ways with peripheral devices using the Remote Interface Cable port. This radio offers the following modes:

- ❖ **PC Control Mode**
Program and control your scanner from a PC using Uniden's E-Scanner software.
- ❖ **Clone Mode**
Clone all the frequencies, trunking talkgroups, and fleet maps programmed into your scanner to another BC250D scanner or BC785D.

PC Control Mode

To connect Scanner to PC:

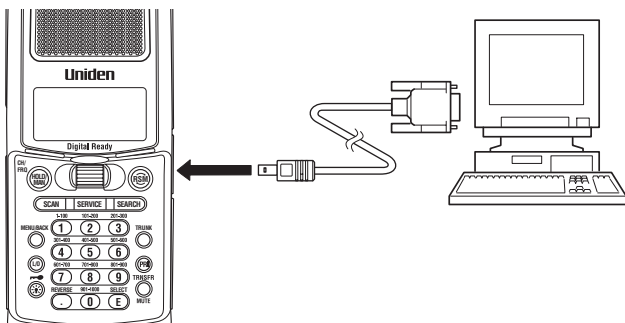

Plug the smaller end of the supplied Remote Interface Cable into the remote port in accordance with the direction of the ◀ mark which is on the right side of the scanner. Plug the other end of the cable (DB-9 serial connector) into a personal computer's serial port. A few PC's may require an adapter, most will not. Of course, make sure your PC is turned ON.

To program your scanner:

You can program and control your scanner remotely from a PC using Uniden's E-Scanner software.

After connecting the scanner to a PC, turn the scanner ON.

To use the Remote (PC Control) mode, you must install Uniden's E-Scanner software and use as directed. Make sure that your scanner is connected to the serial port of the PC using the Remote Interface Cable.

Start Remote Mode and Change Transfer Speed:

Through the Menu system, select 3: SYSTEM OPTION / 5: PC CONTROL by rotating the **VFO** and pressing **E**. To start Remote mode, choose from the transfer speed list except for 5: OFF.

SPEED
3: 9600 bps
4: 19200 bps
5: OFF

A unique feature of the BC250D is that all the front panel keys as well as the **VFO** on the radio remain operational in Remote mode.

For information on purchasing cables, connectors, and E-Scanner software to program and control your BC250D, you can contact the following:

Uniden Parts Department (800) 554-3988
(Hours are from 7:00 a.m. to 5:00 p.m. Central Time
Monday through Friday)

scanner.uniden.com

PC Control Parameter

For your information:

Transfer speed : 2400/4800/9600/19200 bps (adjustable)
Start/Stop : 1 bit, 1 bit
Data Length : 8 bit
Parity bit : None
Code : ASCII code
Flow Control : None
Return Code : Carriage Return only

Clone Mode

You will need to purchase a Gender Changer and a null modem adapter. Gender Changer cables are available as male to male or male to female. Even if the Gender Changer you buy already has the male to male connectors, you will still have to have the null modem adapter. On the next page you will see the pin connections that are internal to a standard device. (These items are available at your local electronics stores.)

To connect the Scanner to Scanner:

Plug the smaller end of each of the supplied Remote Interface Cables into the remote ports in accordance with the direction of the ◀ marks which are on the right sides of each of the two scanners.

Plug the other ends of the cables (DB-9 serial connector) together using a DB-9 to DB-9 null modem adapter, and a Gender Changer Cable available at most computer stores.

Null Modem Adapter
Pin connections

Female DB9	Male DB9
1	4
2	3
3	2
4	6 & 1
5	5
6	4
7	8
8	7
9	Not used

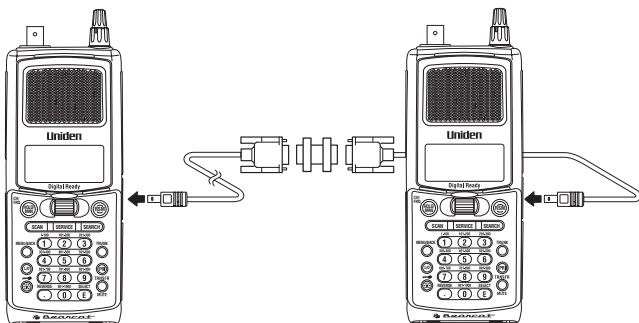

You can clone all of the programming of one BC250D into another, including frequencies, talkgroup IDs, alpha tags, delay settings, etc. After connecting the two scanners, turn the radios ON. Prepare each scanner for clone mode as follows.

1. Press **MENU/BACK**.
2. Select 3: SYSTEM OPTION / 6: CLONE by rotating the **VFO** and pressing **E**.
3. Determine the scanner that has the frequency data that you want to transfer. This one must be set up as the "Master Unit", and the other must be set as the "Slave Unit".
4. On the scanner that is the "Master Unit", select **MASTER**, then press **E**.
5. On the scanner that is the "Slave Unit", select **SLAVE**, then press **E**.

```
CLONE
SELECT UNIT
MASTER
SLAVE
```

```
CLONE
SELECT UNIT
MASTER
SLAVE
```

6. Press **SCAN** on both scanners.
The data transfer begins from the Master Unit to the Slave Unit.

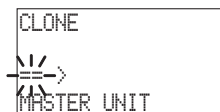

During the data transfer, both scanners show the following displays.

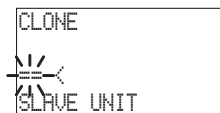

When the data transfer is complete, COMPLETE displays.

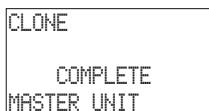

If the data transfer is not successful, the following error message will appear.

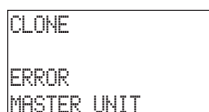

Note: To clear ERROR, press \odot (decimal key).
To exit the Clone mode, press **MENU/BACK** repeatedly.

Note: Once you have completed the cloning of the scanners, reset the scanners by turning the scanners OFF and then ON again. This is particularly important to know if you wish to Clone another scanner right away.

Additional Features

The following additional features are designed for you to customize your scanner. Once these features have been turned ON or OFF, they will remain as they are set until you reset them, even if you turn the scanner OFF and then ON again.

Dimmer

To change brightness of the display:

1. Press **MENU/BACK**.
2. Select 3:SYSTEM OPTION / 1:DIMMER / 1:DIMMER LIGHT by rotating the **VFO** and pressing **E**.
3. Select one from 1:HIGH or 2:MEDIUM by rotating the **VFO** and pressing **E**.

To change lighting time:

1. Press **MENU/BACK**.
2. Select 3:SYSTEM OPTION / 1:DIMMER / 2:DIMMER TIME by rotating the **VFO** and pressing **E**.
3. Select 1:15 SECONDS or 2:INFINITE by rotating the **VFO** and pressing **E**.

Enter Lock

You can lockout the keypad to prevent re-programming of channels, talkgroups and tones (see page 92).

1. Press **MENU/BACK**.
2. Select 3:SYSTEM OPTION / 4:ENTER LOCK by rotating the **VFO** and pressing **E**.
3. Select 1:ON by rotating the **VFO** and pressing **E**.

Key Lock

Key Lock prevents accidental key entries except the following keys (**KEYLOCK**, **HOLD/MAN** and **RSM**).

1. Press and hold  for 2 seconds to turn **KEYPAD LOCK ON** or **KEYPAD LOCK OFF**, and then you will hear two beeps.
If you press any key (except **KEYLOCK**, **HOLD/MAN** and **RSM**) when Key Lock is ON, **KEYPAD LOCK ON** appears on the display.

Key Beep Option

To choose key beep sound 1: ON or 2: OFF:

1. Press **MENU/BACK**.
2. Select 3: SYSTEM OPTION / 3: KEY BEEP by rotating the **VFO** and pressing **E**.
3. Select 1: ON or 2: OFF by rotating the **VFO** and pressing **E**.

Screen Mask

The trunk, frequency, receiving mode, and signal meter indications on the display are masked when this feature is activated (except while in Search mode). This feature reduces the amount of displayed information.

Note: While Screen Mask is ON, Enter Lock is active.

1. Press **MENU/BACK**.
2. Select 3: SYSTEM OPTION / 2: SCREEN MASK by rotating the **VFO** and pressing **E**.
3. Select 1: ON or 2: OFF by rotating the **VFO** and pressing **E**.

Reverse Mode

This key will allow you to observe the reverse frequency of the repeater. While pressing **REVERSE**, the standard pair frequency will be displayed. For a list of the standard pair frequencies, refer to the table "Reverse List" in the Appendix. If the frequency that you have chosen does not have an offset frequency, the display will indicate **ERROR** and **NO REVERSE**. This feature does not work in the Weather Search mode.

Channel Step Selection

You can set channel steps, 5 kHz - 100 kHz or Auto, in Conventional mode or Chain Search mode. The default receive mode should be the proper mode setting in almost all cases. You may wish to set some VHF channels for NFM mode, depending on any adjacent channel interference problems. WFM is typically only used for broadcast frequencies such as TV audio or FM radio.

See **STEPS** in "Menu Description" for details.

Mute On/Off

To manually turn ON the Mute function, press and hold **MUTE** until **MUTE ON** is displayed.

You will not hear any audio. This feature does not function in the WX Alert mode, because the audio is already muted. To turn it OFF, press and hold **MUTE** again.

Receiving Mode Selection

You can also set the receiving mode, AM or FM etc., in Conventional mode or Chain Search mode.

See **MODE** in "Menu Description" for details.

Frequency and Channel Tuning with the VFO Control

The **VFO** knob can be used for stepping through frequencies or stepping through memory channels (for Conventional channels or Talkgroup ID Scan Lists).

To switch the setting for the **VFO** control, press and hold **HOLD/MAN** for 2 seconds. This will change modes from Channel to Frequencies or Frequencies to Channels.

1. In Conventional mode, when the setting for the **VFO** is channel, rotate the **VFO** to move up (to step up through channels) or down (to step down through channels). If you are in Trunk Manual mode, you will step through Scan List memory locations.
2. In Chain Search mode, when the setting for the **VFO** is frequency, rotate the **VFO** to move up to step up through frequencies sequentially or to down to step down through frequencies. To change the step, you will need to go into the Chain Search menu and adjust the step for the desired memory location.

Care and Maintenance

General Use

- Turn the scanner OFF before disconnecting the power.
- Always write down the programmed frequencies in the event of memory loss.
- If memory is lost, simply reprogram each channel. The display shows 000.0000 in all channels when there has been a memory loss.
- Always press each button firmly until you hear the entry tone for that key entry, unless you have turned 2: OFF the 3: KEY BEEP in the menu system.

Location

- Do not use the scanner in high-moisture environments such as the kitchen or bathroom.
- Avoid placing the unit in direct sunlight or near heating elements or vents.
- If the scanner receives strong interference or electrical noise, move it or its antenna away from the source of the noise. If possible, a higher elevation, may provide better reception.

Cleaning

- Disconnect the power to the unit before cleaning.
- Clean the outside of the scanner with a mild detergent. To prevent scratches, do not use abrasive cleaners or solvents. Be careful not to rub the LCD window.
- Do not use excessive amounts of water.

Repairs

- Do not attempt any repair. The scanner contains no user serviceable parts. Contact the Uniden Customer Service Center or take it to a qualified repair technician.

Birdies

- All radios can receive birdies (undesired signals). If your scanner stops during Scan mode and no sound is heard, it may be receiving a birdie. Birdies are internally generated signals inherent in the electronics of the receiver.

Press **L/O** to lockout the channel, and then press **RSM** to resume scanning.

Troubleshooting

If your BC250D is not performing properly, try the following steps.

Problem	Suggestion
Scanner won't work.	<ol style="list-style-type: none"> 1. Check the connections at both ends of the AC Adapter. 2. Turn ON the wall switch of your room. You could be using an outlet controlled by the wall switch. 3. Move the AC Adapter to another wall outlet. 4. Check to see if Key Lock is ON (see page 84).
Improper reception.	<ol style="list-style-type: none"> 1. Check the antenna connection. 2. Move the scanner. 3. You may be in a remote area which could require an optional multi-band antenna. Check with your dealer or local electronics store.
Scan won't stop.	<ol style="list-style-type: none"> 1. Adjust squelch threshold - refer to page 15, "Setting the Squelch". 2. Check the antenna connection. 3. Check to see if many of the channels are Locked Out. If so, the scanner has less chance of finding an active channel. 4. Review each channels frequency to see if it is still stored in Memory and is correct. 5. Its possible that none of the programmed frequencies are currently active.
Scan won't start.	<ol style="list-style-type: none"> 1. Press the SCAN key again. 2. Adjust the SQUELCH control. 3. Check to see if all channels are Locked Out.
Weather Scan won't work.	<ol style="list-style-type: none"> 1. Adjust squelch threshold - refer to page 15, "Setting the Squelch". 2. Check the antenna.

If you experience difficulty while in TrunkTracker mode, try the following steps.

Problem	Suggestion
Scanner won't track.	<ol style="list-style-type: none"> 1. Missing the Data Frequency 2. Change to a Type 1 Scanner setup. Review "Fleet Map Programming" on page 70.
Scanner won't stop during Scan List mode.	<ol style="list-style-type: none"> 1. No IDs have been programmed. 2. The IDs you have stored are not active.
Scanner will not acquire data channel.	<ol style="list-style-type: none"> 1. Adjust the squelch for Trunking mode See page 54. 2. Missing the frequency used for the data channel. Check your frequency list.
Missing replies to conversations.	<ol style="list-style-type: none"> 1. Change to a Type 1 scanner setup. Review "Fleet Map Programming" on page 70. 2. Try another Preset Fleet Map or Program your own Fleet Map. 3. Check to see that all of the systems frequencies have been entered.
Channel Activity Indicators are flashing but no sound is heard.	<ol style="list-style-type: none"> 1. May be a telephone interconnect call, which are intentionally blocked by your scanner. 2. The ID on your display is not active.
Scanner not tracking an EDACS system properly.	<ol style="list-style-type: none"> 1. Logical channel numbers (frequencies) for the system are not programmed in the correct order. Check frequency resources and reprogram. 2. Not all frequencies for the system are programmed. Check frequency resources.

Problem	Suggestion
APCO P25 CARD NOT INSTALLED appear when the scanner is turned ON.	1. Check to see if the P-25 Card is properly installed.
Neither APCO P25 CARD INSTALLED nor APCO P25 CARD NOT INSTALLED appear when the scanner is turned ON.	1. Check to see if the P-25 Card Mode is 1: ENABLE or 2: DISABLE in the Menu mode.
Scratchy or robotic sound is heard during communications.	1. Move to a location where the signal strength is strong. 2. Modulation accuracy of transmissions sent can be low.
Digital communication is not heard.	1. Verify the accuracy of the frequencies of the P-25 system you are trying to monitor. 2. You might be in a dead-spot for the P-25 system you are trying to monitor. Check other locations in the area.
DATA sound is heard at the beginning of digital communications.	1. APCO project 25 systems can send data before voice communication. 2. Data sound can be heard when signal strength is weak.
Robotic sound is heard.	1. Check to see if the ENC message appears on the display. The scanner doesn't monitor encrypted voice communications.
When CARD ERROR appears every 10 seconds while you are using P-25 Card.	1. Re-install the P-25 Card.

If you still cannot get satisfactory results while using your scanner or if you want additional information, please call or write the Uniden Parts and Service Division. The address and phone number is listed in the warranty at the end of this manual. If you would like immediate assistance, please call Customer Service at (800)297-1023.

If you have internet access, you can visit **scanner.uniden.com** for additional information.

Specifications

Certified in accordance with FCC Rules and Regulations Part 15, Subpart C, as of date of manufacture.

Channel:	1000
Banks:	10 (100 channels each)
Service Bands:	12 preprogrammed search bands (including the NOAA Weather Service band)
Frequency Range:	25.0 - 27.995 MHz AM 28.0 - 53.99 MHz FM 54.0 - 71.95 MHz WFM 72.0 - 75.995 MHz FM 76.0 - 87.95 MHz WFM 88.0 - 107.9 MHz WFM 108.0 - 136.975 MHz AM 137.0 - 161.995 MHz FM 162.0 - 173.9875 MHz FM 174.0 - 215.95 MHz WFM 216.0 - 224.995 MHz FM 225.0 - 399.95 MHz AM 400.0 - 512.0 MHz NFM 806.0 - 823.9875 MHz NFM 849.0125 - 868.9875 MHz NFM 894.0125 - 956.0 MHz NFM 1240.0 - 1300.0 MHz NFM
Operating Temperature:	-20 °C to +60 °C (-4°F to 140°F)
Scan Rate:	100 channels per second MAX. (conventional mode)
Search Rate:	100 steps per second MAX. (Normal Search) 300 steps per second MAX. (Turbo Search)
Scan Delay:	2 seconds
Audio Output:	240 mW nominal (8Ω internal speaker) 38 mW nominal (32Ω stereo headphone) 9 mW nominal (64Ω earphone)
Internal Speaker:	8 ohms (36 mm outer diameter)
Power Requirements:	AD600U AC Adapter (12V DC, 500mA) or 4.8V DC 1500mAh (internal battery)
Antenna:	Rubber Antenna (included)
Antenna Jack:	BNC type
External Jacks:	DC 12 V Power Jack (center is positive) Remote Jack Earphone Jack
Size:	65mm (W) x 45mm (D) x 153mm (H)
Weight:	350 g (12 3/8 oz.)

Features and specifications are all subject to change without notice.

Glossary of Terms

Alpha tag - This term refers to an alphanumeric text tag that you can enter to describe the individual frequencies that you have programmed. Rather than having to associate a specific frequency to the individuals that are using it, you can enter the actual name of the group. This will eliminate the need for memorizing the group's frequency.

Attenuator - This scanner comes with a feature to attenuate or reduce the signal strength. The built-in attenuator can be turned on specific frequencies to prevent strong signals from overloading the scanner input, possibly damaging the scanner or missing other transmissions due to the repeated stopping on the stronger signal.

Clone - This term identifies the ability to set up a duplicate scanner. This function allows you to clone all the programming information, including frequencies, talkgroups and alpha tags as well as bank settings and other parameters from one BC250D to another or BC785D.

Control Channel - This is the frequency within a trunking system that runs the system. On Control Channels (sometimes called Data Channels) you will hear a buzz saw sound. For the most part, it is the sound of the system's central computer directing talkgroups to particular voice (working) frequencies within the system.

CTCSS - (Continuous Tone Controlled Squelch System) refers to a system where the radio receivers are equipped with tone responsive devices which allow audio signals to appear at the audio output, select voice processing such as scrambling or control repeater functions only when a carrier modulated with a specific tone is received. This method may be used to restrict access to the repeater or receiver, or reduce interference where several stations with output frequencies in close proximity of each other make it difficult to hear the conversation you are interested in. With CTCSS squelching, you can eliminate the possibility of hearing unwanted conversations by selecting one of the 38 standard subaudible tones. You will only hear those transmissions that have been programmed on specific frequencies with the specific subaudible tone that you have selected.

DCS - (Digital Controlled Squelch) refers to a system where the radio receivers are equipped with data burst responsive devices which allow audio signals to appear at the audio output, select voice processing such as scrambling or control repeater functions only when a carrier modulated

with specific data burst is received. This method may be used to restrict access to the repeater or receiver, or reduce interference where several stations with output frequencies in close proximity of each other make it difficult to hear the conversation you are interested in. With DCS squelching, you can eliminate the possibility of hearing unwanted conversations by selecting one of the 104 standard data burst subaudible tones. You will only hear those transmissions that have been programmed on specific frequencies with the specific subaudible tone that you have selected.

Enter Lock - This is the term used for locking the keypad. This prevents accidental re-programming of channels and talkgroups entered into memory. The default setting is OFF.

When ENTER LOCK is enabled, the following functions will be disabled:

- Enter or modify the Memory Channel frequency
- Enter or modify the Tone information
- Enter or modify the Trunking ID. (this can be modified through the menu screen.)

FIPS Codes - For the purpose of broadcasting weather information, the NWS (National Weather Service) has divided the United States into regions by state and county (or parish, where applicable) then assigned a 6 digit FIPS code to identify each county or parish. The first digit represents the county subdivision, the next two represents the state, and the last three digits represent the county or parish. Your scanner can receive all SAME alert signals broadcasted within about a 50-mile radius of where you install it. So if you only want to hear the counties that are nearest to your area, you can choose specifically the FIPS code of areas that you want. This lets you avoid hearing warnings that apply to an area within a 50-mile radius but not necessarily in your county or parish.

I-Call - Most communications within a trunked system are group calls where one unit (such as a dispatcher) communicates with all the units within her group (all the patrol vehicles on the east side of town, for example). The units within this group comprise what is typically known as a talkgroup. There are some communications which are direct unit-to-unit conversations where one individual converses with another individual. The call is initiated by a radio and is directed to another single radio. Within the system, no one outside of these two users hears the conversation. This call is referred to as I-Call.

Key Beep - This is another term for the tone you hear as a keypad acknowledgement beep. The default setting is on. If you have turned the Key Beep off, you now have a silent keypad. You will not hear a tone each time you press a key.

NWR S.A.M.E. Weather Alert - In 1994, the National Oceanic and Atmospheric Administration (NOAA) began broadcasting coded signals called FIPS (Federal Information Processing System) codes along with the standard weather broadcasts for stations in your area. These codes identify an emergency and the specific geographic area (such as your county) affected by the emergency. The scanner was developed with SAME (Specific Area Messaging Encoding) technology. This allows you scanner to receive, interpret, and display the information about the codes so you can determine if the emergency might affect you area. Each FIPS code identifies a specific geographic area (defined by the National Weather Service) so your scanner sounds an alert only when a weather emergency is declared in those locations. This helps you more efficiently track the weather conditions in and around your area.

PC Control - This term is associated with the ability to program frequencies and other useful information via a computer by means of third party software. You can change the transfer speed on the scanner needed to be compatible with your PC. (See page 81)

Scan List - When you designate a bank to be a trunking bank, your scanner sets up 10 Scan Lists, which are simply list of your favorite IDs. Each list can contain up to 10 IDs, so you can store a total of 100 IDs for each trunk bank. These lists are designed to help you organize the trunking system users into categories.

Screen Mask - Screen Mask reduces the amount of information that appears on the display. Alpha tags that you have set for a channel along with a few function icons will appear only on the display. This mode is particularly useful in public safety vehicles where that are already overloaded with information. Screen Mask does not work in Search mode.

Status Bit - This term refers to Motorola Type II systems. There is a method by which special types of communications utilize unique talk group numbers. For example, if all emergency calls are set to occur on a specific talk group number then you will not miss the transmission even if you have not programmed all the talk group numbers. With the Status Bit on and you have programmed the unique number, then you don't have to

worry what the rest of the groups numbers are. The topic of interest will be picked up.

Talkgroup - A group of users within a trunked system that communicates with one another.

Appendix

Preset Fleet Maps

Preset Map 1

Block	Size Code
0	SIZE CODE 11
1	SIZE CODE 11
2	SIZE CODE 11
3	SIZE CODE 11
4	SIZE CODE 11
5	SIZE CODE 11
6	SIZE CODE 11
7	SIZE CODE 11

Preset Map 2

Block	Size Code
0	SIZE CODE 4
1	SIZE CODE 4
2	SIZE CODE 4
3	SIZE CODE 4
4	SIZE CODE 4
5	SIZE CODE 4
6	SIZE CODE 4
7	SIZE CODE 4

Preset Map 3

Block	Size Code
0	SIZE CODE 4
1	SIZE CODE 4
2	SIZE CODE 4
3	SIZE CODE 4
4	SIZE CODE 4
5	SIZE CODE 4
6	SIZE CODE 12
7	(SIZE CODE 12)

Preset Map 4

Block	Size Code
0	SIZE CODE 12
1	(SIZE CODE 12)
2	SIZE CODE 4
3	SIZE CODE 4
4	SIZE CODE 4
5	SIZE CODE 4
6	SIZE CODE 4
7	SIZE CODE 4

Preset Map 5

Block	Size Code
0	SIZE CODE 4
1	SIZE CODE 4
2	SIZE CODE 12
3	(SIZE CODE 12)
4	SIZE CODE 4
5	SIZE CODE 4
6	SIZE CODE 4
7	SIZE CODE 4

Preset Map 6

Block	Size Code
0	SIZE CODE 3
1	SIZE CODE 10
2	SIZE CODE 4
3	SIZE CODE 4
4	SIZE CODE 12
5	(SIZE CODE 12)
6	SIZE CODE 12
7	(SIZE CODE 12)

Preset Map 7

Block	Size Code
0	SIZE CODE 10
1	SIZE CODE 10
2	SIZE CODE 11
3	SIZE CODE 4
4	SIZE CODE 4
5	SIZE CODE 4
6	SIZE CODE 4
7	SIZE CODE 4

Preset Map 8

Block	Size Code
0	SIZE CODE 1
1	SIZE CODE 1
2	SIZE CODE 2
3	SIZE CODE 2
4	SIZE CODE 3
5	SIZE CODE 3
6	SIZE CODE 4
7	SIZE CODE 4

Preset Map 9

Block	Size Code
0	SIZE CODE 4
1	SIZE CODE 4
2	SIZE CODE 0
3	SIZE CODE 0
4	SIZE CODE 0
5	SIZE CODE 0
6	SIZE CODE 0
7	SIZE CODE 0

Preset Map 10

Block	Size Code
0	SIZE CODE 0
1	SIZE CODE 0
2	SIZE CODE 0
3	SIZE CODE 0
4	SIZE CODE 0
5	SIZE CODE 0
6	SIZE CODE 4
7	SIZE CODE 4

Preset Map 11

Block	Size Code
0	SIZE CODE 4
1	SIZE CODE 0
2	SIZE CODE 0
3	SIZE CODE 0
4	SIZE CODE 0
5	SIZE CODE 0
6	SIZE CODE 0
7	SIZE CODE 0

Preset Map 12

Block	Size Code
0	SIZE CODE 0
1	SIZE CODE 0
2	SIZE CODE 0
3	SIZE CODE 0
4	SIZE CODE 0
5	SIZE CODE 0
6	SIZE CODE 0
7	SIZE CODE 4

Preset Map 13

Block	Size Code
0	SIZE CODE 3
1	SIZE CODE 3
2	SIZE CODE 11
3	SIZE CODE 4
4	SIZE CODE 4
5	SIZE CODE 0
6	SIZE CODE 0
7	SIZE CODE 0

Preset Map 14

Block	Size Code
0	SIZE CODE 4
1	SIZE CODE 3
2	SIZE CODE 10
3	SIZE CODE 4
4	SIZE CODE 4
5	SIZE CODE 4
6	SIZE CODE 12
7	(SIZE CODE 12)

Preset Map 15

Block	Size Code
0	SIZE CODE 4
1	SIZE CODE 4
2	SIZE CODE 4
3	SIZE CODE 11
4	SIZE CODE 11
5	SIZE CODE 0
6	SIZE CODE 12
7	(SIZE CODE 12)

Preset Map 16

Block	Size Code
0	SIZE CODE 3
1	SIZE CODE 10
2	SIZE CODE 10
3	SIZE CODE 11
4	SIZE CODE 0
5	SIZE CODE 0
6	SIZE CODE 12
7	(SIZE CODE 12)

User Defined Fleet Maps

Type I Programming Information

When a Type I system is designed, the address information for all the IDs are divided into 8 equal sized blocks. When you program your scanner to track a Type I system, you must select a size code for each of these blocks. When you have assigned a size code to all 8 blocks, you have defined the Fleet Map for the system you're tracking. Each size code determines the number of Fleets, Subfleets, and IDs each block will have. For example, a size code of "4" has one Fleet, which is divided into 16 separate Subfleets, and it has a total of 512 individual IDs.

When a block is assigned a size code, the Fleet or Fleets created within the block are assigned a Type I ID. The way these IDs display on your scanner depends on the block number and the blocks size code. When a Type I ID displays, the left most digit represents the block which contains the ID. The next two or three digits identify which Fleet is active, and the last digit(s) identifies the Subfleet.

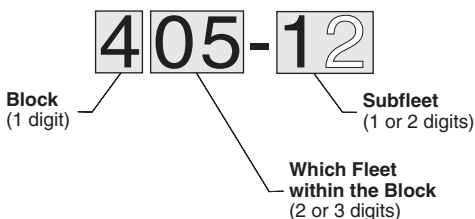

The details concerning how the size codes are selected by a Type I system designer are highly dependent on the specific needs of the systems users. Some organizations may want many subfleets with only a few radios each, while another organization may want only a few subfleets with many radios each. Your task is to program your fleet map with the same size code assignments as the trunked system. If you do this accurately, you'll track all the Fleet-Subfleet combinations used by the system. In other words, you'll hear complete communications while monitoring a trunked system.

If you don't already know the size codes used, you'll have to guess at them. But since you don't have to figure out all the blocks at once, this isn't as hard as it seems. Select a size code for a block, and then press **SCAN**. Now listen to the communications. If you decide you are receiving most of the replies to the conversations with IDs assigned to the block you just programmed, then you've probably selected the right size code and can work on the next block of the map.

Finally, for most public safety systems there are some size codes which are more common. SIZE CODE 3 and SIZE CODE 4 are probably the most common, followed by SIZE CODE 10, SIZE CODE 11, and SIZE CODE 12.

Fleet Map Size Codes

Size	Fleets	Subfleets	IDs	Blocks Used
0	Reserves block for Type II IDs			+
1	128	4	16	1
2	16	8	64	1
3	8	8	128	1
4	1	16	512	1
5	64	4	32	1
6	32	8	32	1
7	32	4	64	1
8	16	4	128	1
9	8	4	256	1
10	4	8	256	1
11	2	16	256	1
12	1	16	1024	2
13	1	16	2048	4
14	1	16	4096	8

Size Code Restrictions

If you select SIZE CODE 12, 13, or 14, there are some restrictions as to which blocks can be used for these codes.

- SIZE CODE 12 can only be assigned to Blocks 0, 2, 4, or 6.
- SIZE CODE 13 can only be assigned to Blocks 0 and 4.
- SIZE CODE 14 can only be assigned to Block 0.

Since these SIZE CODES require multiple blocks, you will be prompted for the next available block when programming a Fleet Map. For example, if you assign Block 0 as an SIZE CODE 12, you will be prompted for Block 2, the next block available, instead of Block 1. And if you assign Block 0 as SIZE CODE 14, you would not see another prompt because all available blocks have been used.

NWR-SAME EVENT CODE

Event Code	Standard	Event Level (Siren Type)				LCD Display
		Warning	Watch	Statement	Test	
Emergency Action Notification	EAN	0				EMG NOTIFY
Emergency Action Termination	EAT	0				EMG TERMINATE
National Information Center	NIC	0				NATIONAL INFO
Tornado Warning #	TOW ^(or TOR)	0				TORNADO
Service Thunderstorm Warning #	SVW ^(or SVR)	0				THUNDERSTORM
Flash Flood Warning	FFW	0				FLASH FLOOD
Flash Warning	FLW	0				FLOOD
Winter Storm Warning	WSW	0				WINTER STORM
Blizzard Warning	BZW	0				BLIZZARD
High Wind/ Dust Storm Warning	HWW	0				HIGH WIND
Radio logical Hazard Warning	RHW	0				RADIOLOGICAL
Civil Danger Warning	CDW	0				CIVIL DANGER
Local Area Emergency	LAE	0				LOCAL EMG
Hazardous Material Warning	HMW	0				HAZARDOUS
Civil Emergency Message	CEM	0				CIVIL EMG
Immediate Evacuation Warning	IEW	0				EVACUATION
Immediate Evacuation Notice	EVI	0				EVACUATE NOTE
Law Enforcement Warning	LEW	0				LAW ENFORCEMENT
Fire Warning	FRW	0				FIRE

Event Code	Standard	Event Level (Siren Type)				LCD Display
		Warning	Watch	Statement	Test	
Hurricane/Tropical Storm Warning	HUW	0				HURRICANE
Tsunami Warning	TSW	0				TSUNAMI
Coastal Flood Warning	CFW	0				COASTAL FLOOD
Special Marine Warning	SMW	0				SPECIAL MARINE
Avalanche Warning	AVW	0				AVALANCHE
Volcano Warning	VOW	0				VOLCANO
Shelter In Place Warning	SPW	0				SHELTER
Civil Danger Watch	CDA		0			CIVIL DANGER
Radiological Hazard Watch	RHA		0			RADIOLOGICAL
Hazardous Material Watch	HMA		0			HAZARDOUS
Winter Storm Watch	WSA		0			WINTER STORM
High Wind/ Dust Storm Watch	HWA		0			HIGH WIND
Tornado Watch	TOA		0			TORNADO
Severe Thunderstorm Watch	SVA		0			THUNDERSTORM
Flash Flood Watch	FFA		0			FLASH FLOOD
Flood Watch	FLA		0			FLOOD
Hurricane/ Tropical Storm Watch	HUA		0			HURRICANE
Tsunami Watch	TSA		0			TSUNAMI
Coastal Flood Watch	CFA		0			COASTAL FLOOD
Avalanche Watch	AVA		0			AVALANCHE
Volcano Watch	VOA		0			VOLCANO

Event Code	Standard	Event Level (Siren Type)				LCD Display
		Warning	Watch	Statement	Test	
Severe Weather Statement	SVS			0		SEVERE WX
Special Weather Statement	SPS			0		SPECIAL WX
Flash Flood Statement	FFS			0		FLASH FLOOD
Flood Statement	FLS			0		FLOOD
Hurricane Statement	HLS			0		HURRICANE
National Periodic Test	NPT				0	NATION PERIOD
Required Monthly Test	RMT				0	MONTHLY
Required Weekly Test	RWT				0	WEEKLY
System Demonstration/ Practice	DMO				Note	SYSTEM DEMO
National Hazard Warning	NHW	0				NATION HAZARD
Unknown Emergency Tune TV	**E	0				UNKNOWN TV
Unknown Warning Tune TV	**W	0				UNKNOWN TV
Unknown Watch Tune TV	**A		0			UNKNOWN TV
Unknown Statement Tune TV	**S			0		UNKNOWN TV

REVERSE LIST

Range	Offset	Range	Offset
29.520 - 29.580	+0.1 MHz	445.000 - 449.9875	-5 MHz
29.620 - 29.680	-0.1 MHz	450.000 - 454.9875	+5 MHz
52.010 - 52.990	+1 MHz	455.000 - 459.9875	-5 MHz
53.010 - 53.990	-1 MHz	460.000 - 464.9875	+5 MHz
143.750	+4.375 MHz	465.000 - 469.9875	-5 MHz
143.900	+4.25 MHz	470.000 - 472.9875	+3 MHz
144.510 - 144.890	+0.6 MHz	473.000 - 475.9875	-3 MHz
145.110 - 145.490	-0.6 MHz	476.000 - 478.9875	+3 MHz
146.010 - 146.385	+0.6 MHz	479.000 - 481.9875	-3 MHz
146.415 - 146.505	+1 MHz	482.000 - 484.9875	+3 MHz
146.595	+1 MHz	485.000 - 487.9875	-3 MHz
146.610 - 146.985	-0.6 MHz	488.000 - 490.9875	+3 MHz
147.000 - 147.390	+0.6 MHz	491.000 - 493.9875	-3 MHz
147.415 - 147.505	-1 MHz	494.000 - 496.9875	+3 MHz
147.595	-1 MHz	497.000 - 499.9875	-3 MHz
147.600 - 147.990	-0.6 MHz	500.000 - 502.9875	+3 MHz
148.125	-4.375 MHz	503.000 - 505.9875	-3 MHz
148.150	-4.25 MHz	506.000 - 508.9875	+3 MHz
222.120 - 223.380	+1.6 MHz	509.000 - 511.9875	-3 MHz
223.720 - 224.980	-1.6 MHz	806.000 - 823.9875	+45 MHz
420.000 - 424.9875	+5 MHz	851.000 - 868.9875	-45 MHz
425.000 - 429.9875	-5 MHz	896.000 - 901.000	+39 MHz
440.000 - 444.9875	+5 MHz	935.000 - 940.000	-39 MHz

CTCSS Frequency List (Hz)

67.0	71.9	74.4	77.0	79.7	82.5	85.4	88.5
91.5	94.8	97.4	100.0	103.5	107.2	110.9	114.8
118.8	123.0	127.3	131.8	136.5	141.3	146.2	151.4
156.7	162.2	167.9	173.8	179.9	186.2	192.8	203.5
210.7	218.1	225.7	233.6	241.8	250.3		

DCS Tone Code

023	025	026	031	032	036	043	047
051	053	054	065	071	072	073	074
114	115	116	122	125	131	132	134
143	145	152	155	156	162	165	172
174	205	212	223	225	226	243	244
245	246	251	252	255	261	263	265
266	271	274	306	311	315	325	331
332	343	346	351	356	364	365	371
411	412	413	423	431	432	445	446
452	454	455	462	464	465	466	503
506	516	523	526	532	546	565	606
612	624	627	631	632	654	662	664
703	712	723	731	732	734	743	754

BC250D Flow Charts

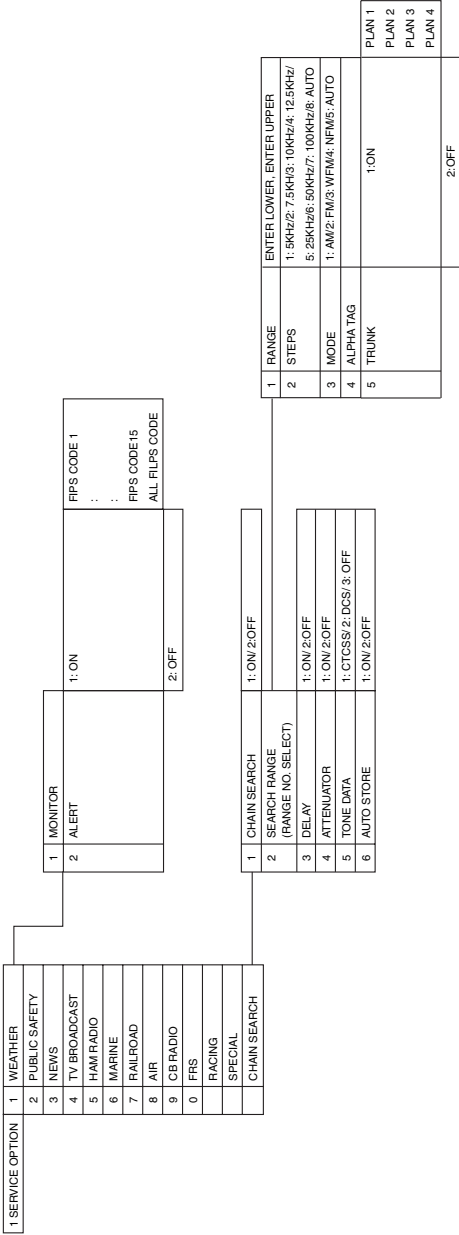

2 SCAN OPTION	1	CONVENTIONAL (CHANNEL SELECT)	FREQUENCY	ALPHA TAG
	2	TRUNK (BANK SELECT)	1: ON/ 2:OFF	
	3	TRUNK (BANK SELECT)	1: CTSS/2: DCS/ 3: OFF	
	4	TRUNK (BANK SELECT)	1: ON/ 2:OFF	
	5	TRUNK (BANK SELECT)	1: ON/ 2:OFF	
	6	TRUNK (BANK SELECT)	1: 5KHz/ 2: 7.5KHz/ 3: 10 KHz/ 4: 12.5 KHz/ 5: 25 KHz/ 6: 50 KHz/ 7: 100 KHz/ 8: AUTO	
	7	TRUNK (BANK SELECT)	1:AM/ 2:FM/ 3:WFM/ 4:NFM	

1	TRUNK TYPE	FREQUENCY	ALPHA TAG
2	TRUNK CHANNEL (CHANNEL SELECT)	1	1: 5KHz/2: 7.5KHz/3: 10KHz/4: 12.5KHz/ 5: 25KHz/6: 50KHz/7: 100KHz/8: AUTO
3	TALK GROUP (ID NO. SELECT)	2	STEPS
4	DELAY	1: ON/ 2: OFF	
5	ID LIST TAG		
6	L/O ID REVIEW		
7	ACTIVITY ID	1: ON/ 2: OFF	
8	I-CALL (MOTOROLA/ EDACS)	1: ON/ 2: OFF/ 3: ONLY	
8	ID SCAN LIST (LTR)		
9	EMERGENCY ALT	1: ON/ 2: OFF	
9	STATUS BIT (MOTOROLA)	1: ON/ 2: OFF	
0	EDACS ID FORM (EDACS)	1: AFS/ 2: DECIMAL	
0	END CODE (MOTOROLA)	1: DETECT/ 2: IGNORE	
	CNTRL CH ONLY (TYPE1/ TYPE2 800,900)	(TYPE2 800/TYPE1 SYSTEM)	
		1: PLAN1/ 2: PLAN2/ 3: PLAN3/ 4: PLAN4/ 5: OFF	
		(TYPE 2 900 SYSTEM)	
		1: ON/ 2: OFF	

1	ON	1	TYPE2 800
2		2	TYPE1
3		3	TYPE2 900

4	TYPE2 UHF	ENTER BASE FREQUENCY	SET FLEET MAP USER CUSTOM / PRESET 1-16
5	TYPE2 VHF	ENTER BASE FREQUENCY	SET BASE CONFIG 1-3
6	EDCS WIDE	ENTER SPACE FREQUENCY	ENTER SPACE FREQUENCY
7	EDCS NARROW	ENTER SPACE FREQUENCY	ENTER SPACE FREQUENCY
8	EDCS SCT.	ENTER SPACE FREQUENCY	ENTER SPACE FREQUENCY
9	LT	ENTER SPACE FREQUENCY	ENTER SPACE FREQUENCY

1	ID
2	ALPHA TAG
3	BEEP ALERT

3 SYSTEM OPTION		DIMMER LIGHT DIMMER TIME	1: HIGH/2: MEDIUM 1: 15SECONDS/2: INFINITE
1	DIMMER		
2	SCREEN MASK	1: ON/ 2:OFF	
3	KEY BEEP	1: ON/ 2:OFF	
4	ENTER LOCK	1: ON/ 2:OFF	
5	PC CONTROL	1: 2400 bps / 2: 4800 bps / 3: 9600 bps/ 4: 19200 bps/ 5: OFF	
6	CLONE	MASTER / SLAVE	
7	DATA SKIP	1: ON/ 2:OFF	
8	SQ MODE	1: CSQ/ 2: TONE SQ/ 3: TONE SEARCH	
9	BANK TAG (SELECT BANK)		
0	P-25 CARD BATTERY SAVE	1: ENABLE/ 2: DISABLE	

One Year Limited Warranty

Important: Evidence of original purchase is required for warranty service.

WARRANTOR: UNIDEN AMERICA CORPORATION (Uniden)

ELEMENTS OF WARRANTY: Uniden warrants, for one year, to the original retail owner, this Uniden product to be free from defects in materials and craftsmanship with only the limitations or exclusions set out below.

WARRANTY DURATION: This warranty to the original user shall terminate and be of no further effect 12 months after the date of original retail sale. The warranty is invalid if the Product is (A) damaged or not maintained as reasonable or necessary, (B) modified, altered, or used as part of any conversion kits, subassemblies, or any configurations not sold by Uniden, (C) improperly installed, (D) serviced or repaired by someone other than an authorized Uniden service center for a defect or malfunction covered by this warranty, (E) used in any conjunction with equipment or parts or as part of any system not manufactured by Uniden, or (F) installed or programmed by anyone other than as detailed by the owners manual for this product.

STATEMENT OF REMEDY: In the event that the product does not conform to this warranty at any time while this warranty is in effect, warrantor will either, at its option, repair or replace the defective unit and return it to you without charge for parts, service, or any other cost (except shipping and handling) incurred by warrantor or its representatives in connection with the performance of this warranty. Warrantor, at its option, may replace the unit with a new or refurbished unit. THE LIMITED WARRANTY SET FORTH ABOVE IS THE SOLE AND ENTIRE WARRANTY PERTAINING TO THE PRODUCT AND IS IN LIEU OF AND EXCLUDES ALL OTHER WARRANTIES OF ANY NATURE WHATSOEVER, WHETHER EXPRESS, IMPLIED OR ARISING BY OPERATION OF LAW INCLUDING, BUT NOT LIMITED TO ANY IMPLIED WARRANTIES OF MERCHANTABILITY OR FITNESS FOR A PARTICULAR PURPOSE. THIS WARRANTY DOES NOT COVER OR PROVIDE FOR THE REIMBURSEMENT OR PAYMENT OF INCIDENTAL OR CONSEQUENTIAL DAMAGES. Some states do not allow this exclusion or limitation of incidental or consequential damages so the above limitation or exclusion may not apply to you.

LEGAL REMEDIES: This warranty gives you specific legal rights, and you may also have other rights which vary from state to state. This warranty is void outside the United States of America.

PROCEDURE FOR OBTAINING PERFORMANCE OF WARRANTY: If, after following the instructions in the owners manual you are certain that the product is defective, pack the Product carefully (preferably in its original packaging). The product should include all parts and accessories originally packaged with the Product. Include evidence of original purchase and a note describing the defect that has caused you to return it. The Product should be shipped freight prepaid, by traceable means, to warrantor at:

UNIDEN AMERICA CORPORATION
Parts and Service Division
4700 Amon Carter Boulevard
Fort Worth, TX 76155

(800) 554-3988, 7 a.m. to 5 p.m. Central Time, Monday through Friday

Thank you for purchasing a Uniden Scanner!

A World Without Wires | Uniden®

www.uniden.com

May be covered under one or more of the following U.S. patents:

4,398,304	4,409,688	4,455,679	4,461,036	4,521,915
4,597,104	4,627,100	4,841,302	4,888,815	4,932,074
4,947,456	5,014,348	5,199,109	5,408,692	5,428,826
5,438,688	5,448,256	5,465,402	5,471,660	5,483,684
5,530,296	5,548,832	5,551,071	5,574,995	5,577,076
5,598,430	5,600,223	5,642,424	5,710,992	5,859,875
5,896,422	5,991,346	5,991,603	6,012,158	6,025,758
6,034,573	6,064,270	6,266,521		

** U.S. Patent Number 4,841,302 is licensed from Gray Electronics, Inc.

FCC WANTS YOU TO KNOW

Changes or modifications to this product are strictly prohibited or operation of this product in any way other than as detailed by the owner's manual, could void your authority to operate this product.

© 2002 Uniden America Corporation, Fort Worth, TX
All rights reserved.

Contains additional foreign articles.
Custom manufactured in the Philippines.

UBZZ01315ZA